

SANWA

Innovative Middle Class Radio Telemetry System

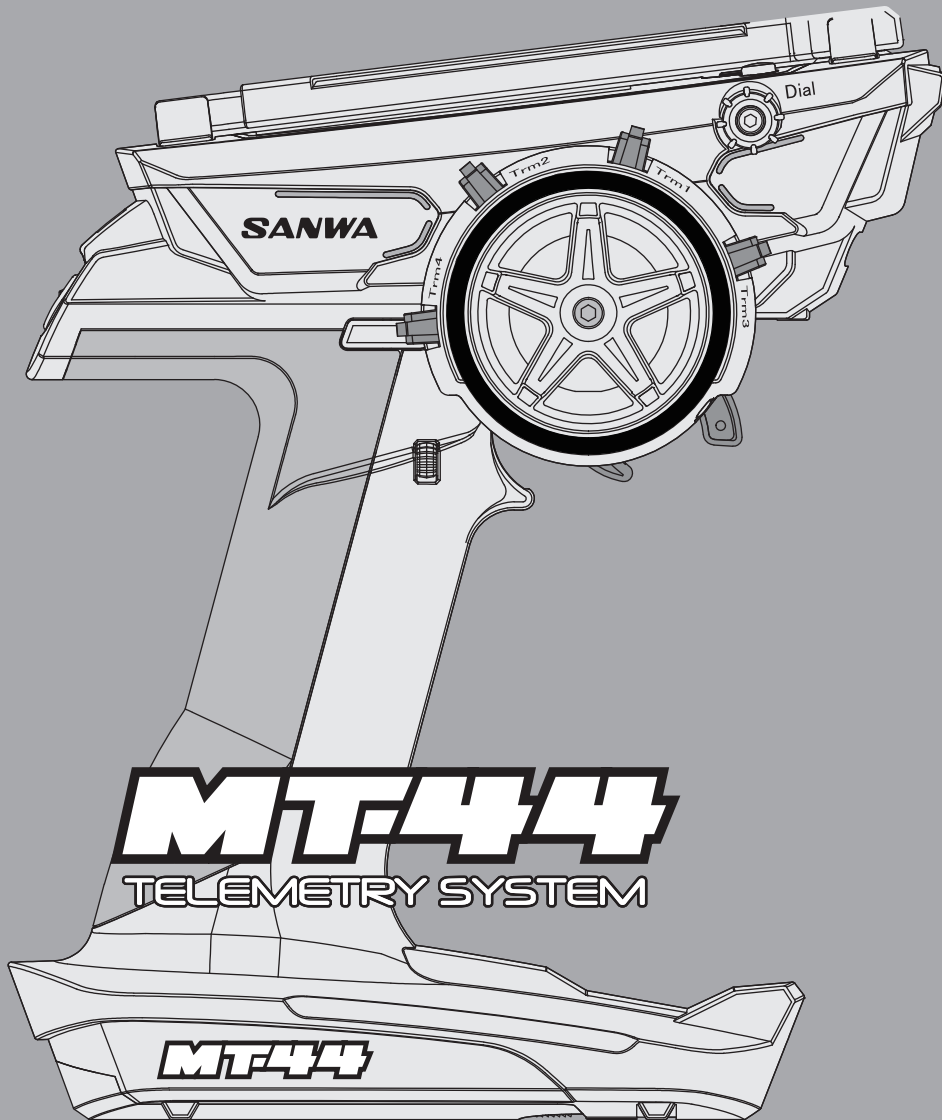

MT44

TELEMETRY SYSTEM

MT44

THE CHOICE OF **CHAMPIONS**

2.4 FH4T
GHZ

Spread Spectrum
Technology By **SANWA**

SSL
CODE: AUX
Synchronized Link

SANWA SUPER RESPONSE
SSR 

Safe Handling of R/C System and Precautions

To use your purchased R/C System properly and safely, please read this instruction carefully and make sure to follow the precautions. Improper use of the product or negligence of following safety precautions can cause trouble to others or harm to the user.

■ For safety, please make sure to follow each of the precautions below.

Warning Precautions for Installation and Operation

● When turning the power switch of R/C System on, please turn on in order of ① Transmitter → ② Receiver. And when turning the power switch off, please do so in order of ① Receiver → ② Transmitter.

☆ If you reverse the order of the switches, it causes sudden high rotation of the engine and the motor and it's extremely dangerous.

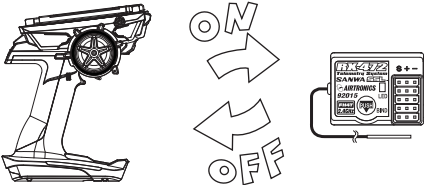

● Please use electrical noise countermeasure on the body of your car.

☆ If metals rub against each other, it causes electrical noise which may lead to abnormal performance. Please be sure that all screws and nuts are not loose.

☆ Nitro or gas engine and electric motor can cause noise also. Please use a noise countermeasure such as a plug with resistor or noise killer condenser.

● Please make sure to run a performance check (signal reception test) of R/C System before operation. When it moves abnormally or it doesn't move, please don't operate. Even if the test result on a desk is normal, please be cautious when operating for the first time especially, since the radio wave arrival distance varies depending on the installation method of the receiver, how the antenna is set, the direction of the transmitter antenna is facing and geography.

● Never operate on a rainy day.

☆ The interior of the transmitter is built with sensitive electronic parts. If water runs on the surface of the case and enters inside, it can cause abnormal performance or malfunction and it can be dangerous.

☆ If the receiver or a servo sinks in the water, immediately collect it and dry the interior. When the interior is dry, please submit it to the Sanwa

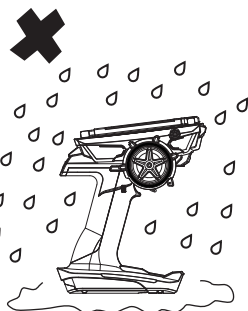

Service for inspection even if it performs normally.

● The receiver is a precise instrument. Please do not add a strong impact or vibration.

☆ Use a thick sponge to prevent vibrations.

● Install the receiver as far as possible from the speed controller, motor and the battery.

● When installing the receiver on a metallic chassis or a carbon chassis, use three layers of double adhesive tape pieces to keep the receiver from touching the chassis.

● When there is a radio disturbance, change the installation location of the receiver or change from a vertical placement to a horizontal placement or vice versa.

● Don't place a motor cord or a battery cord close to the receiver since it can cause abnormal performance.

● Keep the antenna of the receiver out as much as possible. And keep it straight and stretched. Don't cut the extra length of the line or bend it.

☆ It's dangerous when the antenna is short since the range of travelling becomes narrow.

☆ Never cut the antenna.

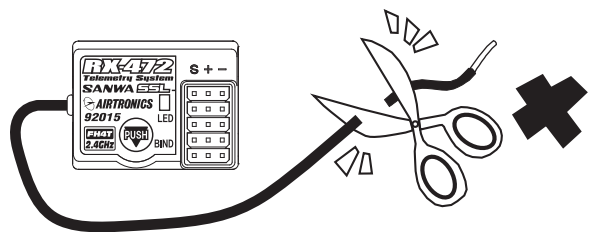

● Don't place the antenna close to a motor cord or a battery cord.

● Using a conductive piano wire on a metallic chassis or carbon chassis can cause abnormal performance from electrical noise. Don't place a piano wire close to the chassis.

Warning Precaution For Operating RC Car

When operating an RC car, please make sure to follow the following notes and avoid giving trouble to others.

- Maintain the body of the car (boat) in a perfect condition and check the safety.
- Do not operate an RC car in a crowd or on a public road.
- Make sure to disconnect the connector of the power battery and remove the power battery from the car after operation.
- When operating simultaneously with other RC users, make sure to have a control staff and follow the instruction of the control staff.
- Try not to interfere with other people's operation.
- Be sure to apply for a radio control insurance. For application to apply a radio control insurance, inquire a radio control operator registration agency.
- Be sure to install a "muffler (sound absorber)" with a silencing effect on an engine car.
- Don't start engine early in the morning.
- Please make sure to clean the location used for operation before you leave.

Note About Operation

- Don't use this RC system for other than model use.

Note Daily Maintenance

- When exhaust gas or fuel of the engine is on the product, wipe with a soft dry cloth. When the product is heavily stained, soak a soft clean cloth with water or neutral detergent, squeeze tightly and wipe with it. Don't use thinner, benzene, alcohol, motor cleaner or brake cleaner since they can damage the surface finishing and alter the quality.

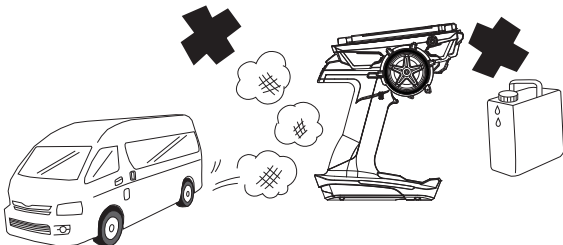



Note About Handling the Transmitter

- Don't hit, drop or subject to strong impact. Touching the transmitter, receiver, servos or FET speed controller with a hand stained with tire traction agent can cause malfunction or deforming the case.

Note Storage Location

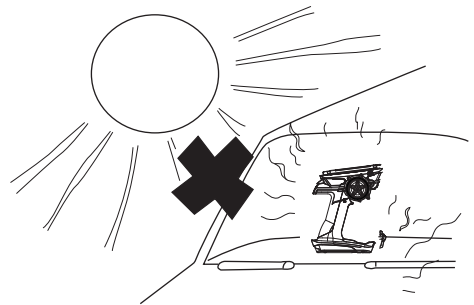
- Don't store the product in the following locations:
 - ☆ Extremely hot or cold place.
 - ☆ Place exposed to the direct sunlight for long hours.
 - ☆ Especially if the product is left in a closed car with a direct sunlight hitting, the temperature inside the car can rise above 80°C depending on the season. It can cause deforming or malfunction.
 - ☆ Place with high humidity and poor ventilation
 - ☆ Place with vibrations
 - ☆ Place with dust, steam or heat
 - ☆ Place that is blown with engine exhaust gas or a place close to a fuel can



What each  Warning marks indicate  Note

Precautions you must follow to avoid accidents or injury

Precautions you must follow to avoid malfunctions

Safe Handling of R/C System and Precautions



Note

Precautions to Use the Product Safely

- 2.4 GHz frequency band is not only used for radio control. This frequency band is shared with ISM (Industry, Science and Medical) band. It can be affected by microwave ovens, wireless LAN, digital cordless telephones, audio equipment, Bluetooth of game machines or cell phones and short-range communication such as VICS. Also, be cautious about being affected by amateur radio and premises radio stations for moving body identification since this frequency band is used for them as well. When a harmful radio frequency interference is done to an existing radio station, stop the transmission of the radio frequency immediately and take a measure to avoid the interference.
- For RC circuit, minimize the use of equipment that can affect 2.4 GHz systems and make sure to check the safety beforehand. Also, follow the instruction of the facility manager.
- When operating the models behind a building or a steel tower, blocking the direction of radio wave transmission can cause reduction of operation response or loss of control. Always operate within the range you can visually check.
- Don't grab the transmitter antenna. Doing so can be dangerous since it can weaken the radio signal output and narrow the range of operation.
- Don't attach any metal parts around the antenna of the transmitter.
- If you have the transmitter's antenna extremely close to a servo or speed controller other than the receiver, it can cause malfunction but it is an influence of a strong high frequency output and it is not abnormal.
- The receiver is a precise instrument. Don't subject it to strong impact or vibrations. Use a thick sponge to prevent vibrations.
- Keep the antenna wire of the receiver out as much as possible. And keep it straight and stretched. Don't cut the extra length of the antenna line or bend it.
- Don't place the antenna wire of the receiver close to a electrical noise source like a motor wire or a battery wire.
- When installing the receiver on a metallic chassis or a carbon chassis, use layers of double adhesive tape pieces to keep the receiver from touching the chassis as much as possible.

INDEX

■ Layout and Specification of the Set.....	5
• Layout of the Set (5)	
• Specification of the Set (5)	
■ Before start using.....	6 - 8
• Adjusting tension of the steering and throttle (6)	
• Adjusting the adjustable trigger (7)	
• About the power source, output format and Bind (8)	
■ About connecting and installing the receiver.....	9-10
• About the receiver, handling the antenna,built-in antenna receiver (9)	
• About connection setup (10)	
■ Names of each part of the transmitter.....	11-12
■ How to use each feature.....	13-60
• About Key Operation (13)	
• About Power On Alarm (13)	
• About the Display Panel (14)	
• About the Menu Structure (15)	
• About Short Cut Menu (16-18)	
• Direct Model Select (16)	
• Quick Setup (17-18)	
• Setting [SETTING] (19-32)	
• Dual Rates (D/R) (19)	
• Speed [SPEED](20)	
• Curve [CURVE] (21-24)	
• Fail Safe [F/S] (25)	
• Base [BASE] (25-28)	
• Reverse [REV] (26)	
• Sub Trim [SUB-T] (26)	
• End Point Adjustment [EPA] (27-28)	
• Trim [TRIM] (29-30)	
• Anti-Lock Brake [ALB] (31)	
• Offset [OFFSET] (32)	
• Throttle Type [TH TYPE] (32)	
• AUX [AUX] (33-36)	
• Step AUX [STEP AUX] (33)	
• Point AUX [POINT AUX](33)	
• 4 Wheel Steering [4WS] (34)	
• Motor On Axle [MOA] (34)	
• AUX Mixing [AUX-MIX] (35)	
• Code AUX [CODE AUX] (36)	
• Timer [TIMER] (37-39)	
• Setup [SETUP] (37,38)	
• Lap Timer [LAP TIMER] (38)	
• Interval Timer [INT TIMER](39)	
• Down Timer [DOWN TIMER] (39)	
• Telemetry [TELEMETRY] (40-44)	
• LOG [LOG DATA] (40)	
• Telemetry Setting [TELEMETRY SETTING] (43)	
• Graph Setting [GRAPH SETTING](44)	
• Telemetry Switch [TELEMETRY SWICH](44)	
• Model [MODEL] (45-48)	
• Model Select [MODEL SELECT] (45)	
• Model Name [MODEL NAME](46)	
• Model Copy [MODEL COPY] (47)	
• Model Clear [MODEL CLEAR] (48)	
• System [SYSTEM] (49-60)	
• Bind [BIND] (49-50)	
• Key Assign Switch [KEY ASSIGN SW](51)	
• Key Assign Trim [KEY ASSIGN TRIM] (52)	
• Custom List [CUSTOM-LIST] (53)	
• AUX TYPE [AUX TYPE] (54)	
• Racing Mode [RACING MODE] (55)	
• Battery [BATTERY] (56)	
• Buzzer [BUZZER] (56)	
• LCD [LCD] (57)	
• LED [LED] (57)	
• Clock [Clock] (58)	
• Setup [SETUP] (58)	
• Calibration [CALIBRATION] (59)	
• Firmware [Firmware] (60)	
■ Key Assign Features Overview.....	61
■ About handling the sensor	62
■ Index.....	63
■ At a time like this.....	64
■ Service and Support	65
■ FCC Compliance Statement.....	66

Names of each part of the transmitter

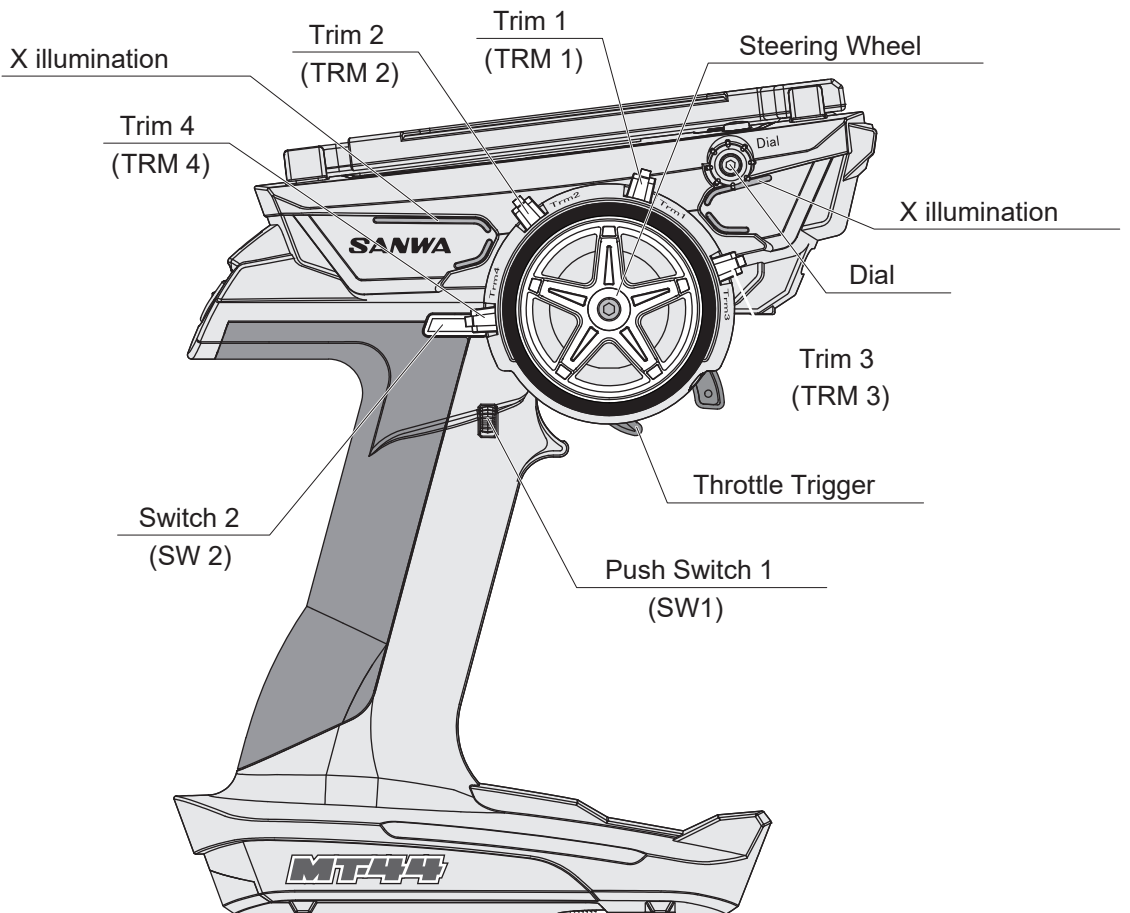
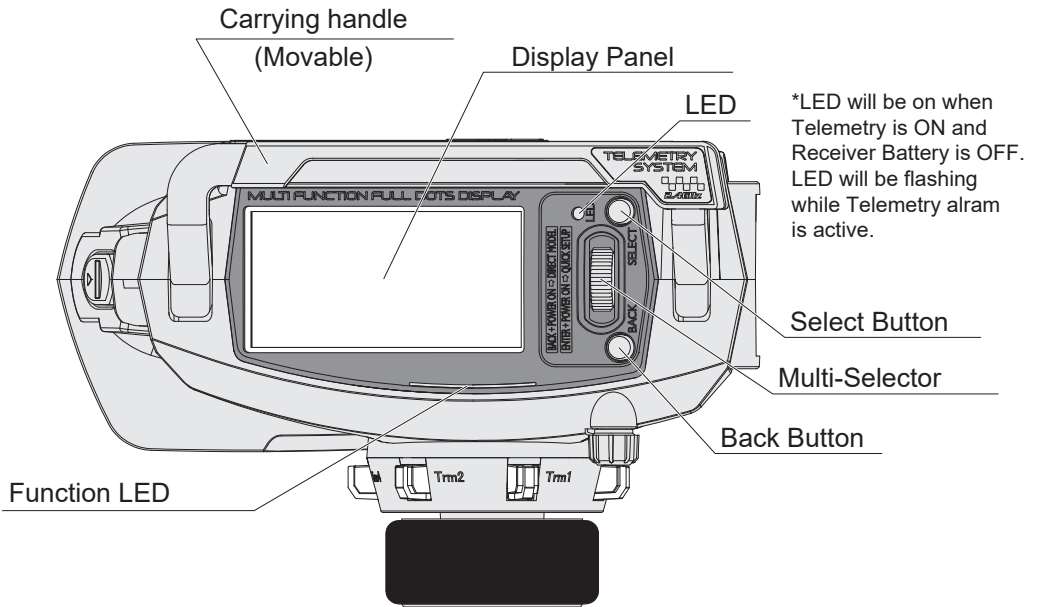

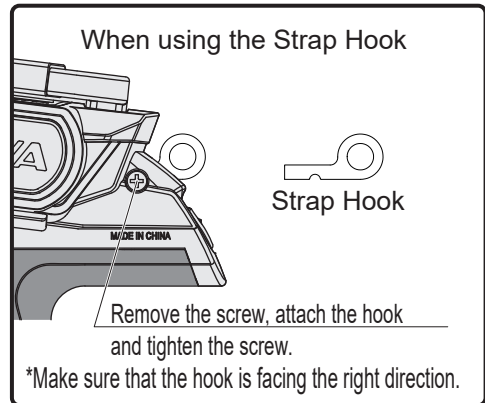
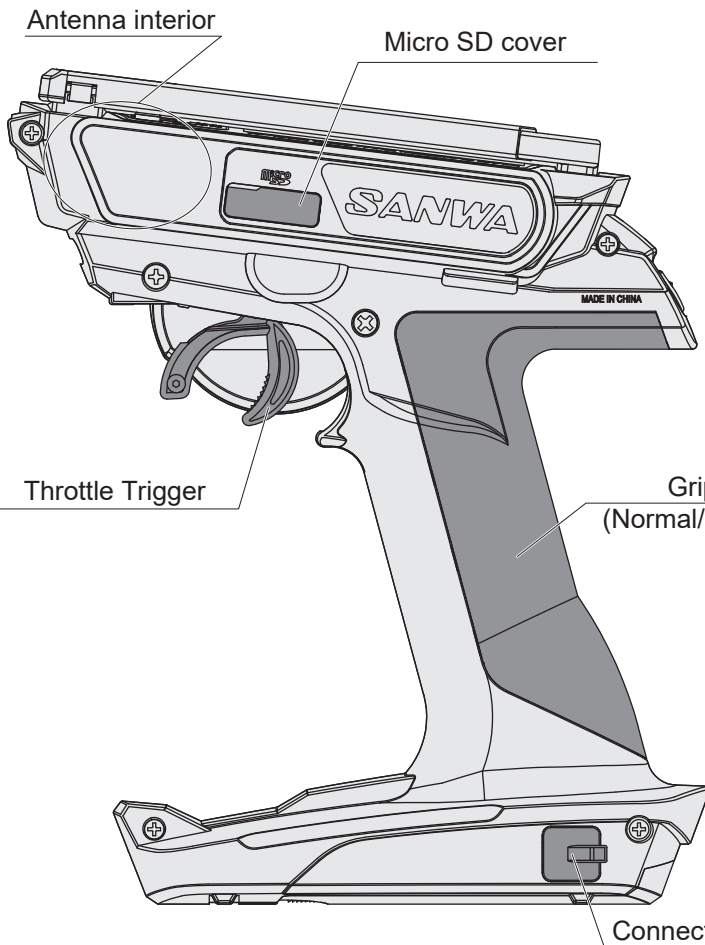
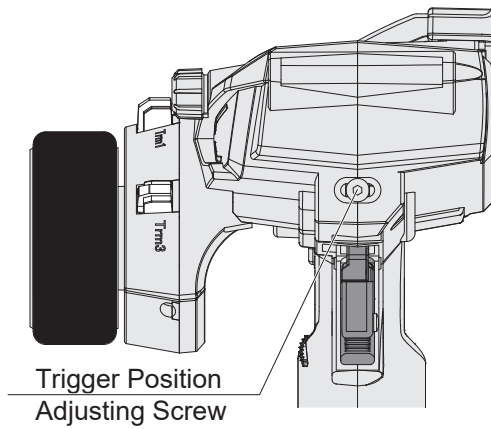
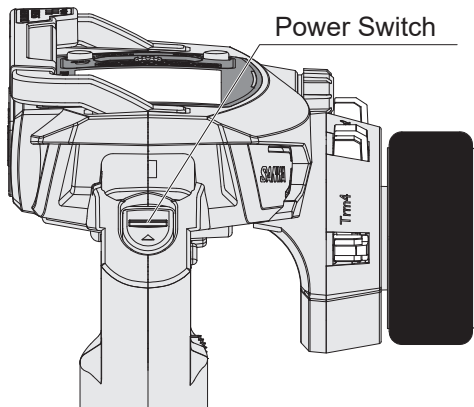

Structure and the Standard of the Set

Structure of the Set

	RX-482 PC (Primary Component)
Transmitter	TX-471
Receiver	RX-482
Servos	—
Accessories	Strap Hook x 1 Trigger Angle Spacer x 1 Brake Trigger +1/+2 x each 1 Grip Pad S size x 1 Receiver Dust Cover x 1 Switch Harness x 1 Instruction Manual x1

●Please check what's included before your use.

Set Specification

<A>Transmitter	
Product No.	TX-471
Output Display	Analog/Digital display (Power Source Voltage Display)
Modulation Method	2.4GHz Spectrum Spread System
Power Source	Size AAA batteries x 3 (Corresponding voltage: DC 2.7 ~ 5.0 V)
Weight	371 g

Receiver	
Item	RX-482
Modulation Method	2.4GHz Spectrum Spread System
Size	18.2x24.4x27.1mm
Power Source	DC3.7~7.4V
Weight	7.1 g

*Be careful with the input voltage. If voltage above allowable voltage is inputted, the transmitter will be damaged.

Before using

Adjusting the steering and throttle tension

With MT-44, the user can easily adjust the tension of the steering/throttle trigger to match operation of the steering/throttle to the user's preference.

Adjusting the steering tension

By inserting a hexagon wrench driver (1.5mm) to the place where the arrow is pointing at in the illustration on the right and turning, you can adjust the tension of the steering spring.

*The spring tension is the softest at the time when the product is shipped out from the factory. As you tighten with a hexagon wrench driver (1.5mm), the spring tension will be hardened.

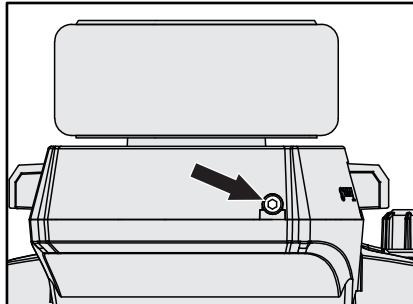

Adjusting TH trigger tension

By inserting a hexagon wrench driver (1.5mm) to the place where the arrow is pointing at in the illustration on the right and turning, you can adjust the tension of the throttle spring.

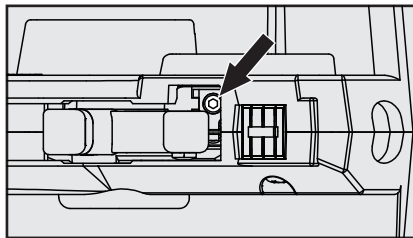

Adjusting the grip pad

The user can choose a grip pad from two types of normal/small to suit the size of the user's hand. (The normal size is installed at the factory.)

Do not pull forcefully because it's locked to the grip of the receiver with tabs of the grip pad (at 11 locations).

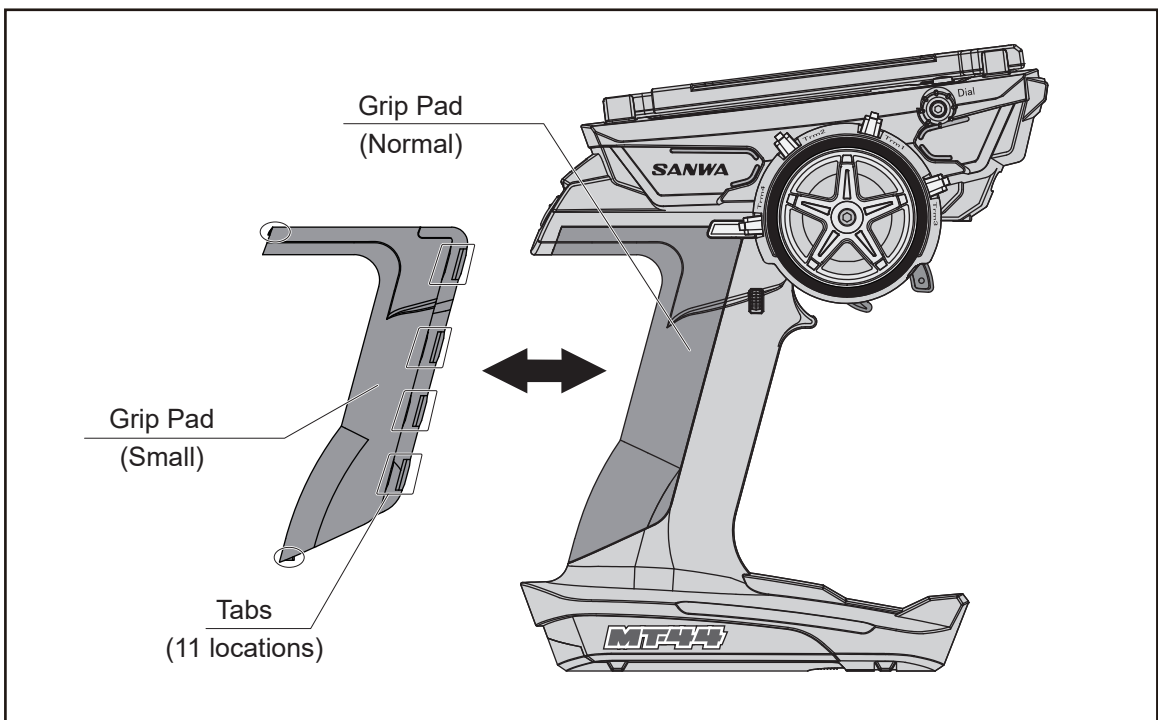

Before using

Adjusting the full adjustable trigger

Adjusting the trigger position

Loosen the fixing screws of the trigger on the back of the transmitter. Then, adjust the adjusting screw of the trigger position on the back of the transmitter to set the trigger at the position of your preference. When you turn the adjusting screw of the trigger position clockwise, the trigger position gauge moves to the direction A. By turning it counter clockwise, the trigger position gauge moves to the direction B.

*The range of the trigger movement is 5mm. If you turn the screw forcefully beyond the range, it can cause malfunction. Once you set the trigger position, tighten the fixing screw and adjusting the trigger is done.

*Be careful with the direction of turning the screw because the trigger position is set at the furthest point of the A side at the factory.

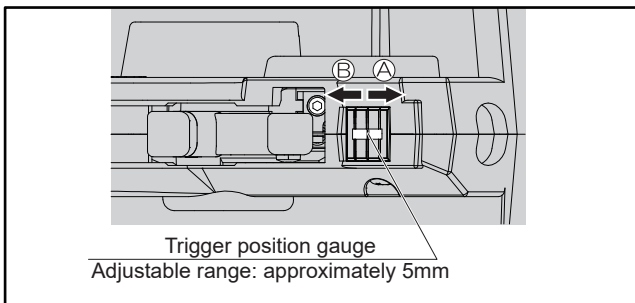
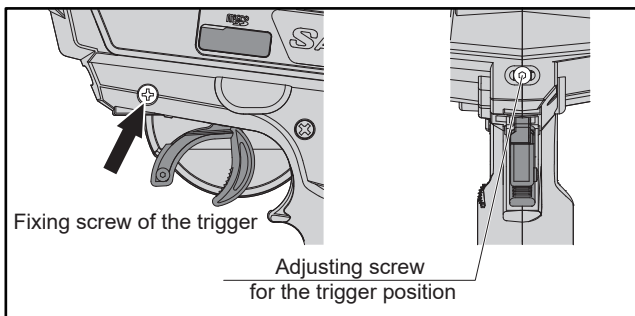

Adjusting the trigger angle

By switching the angle spacer A/B/C, it is possible to adjust the angle of the throttle trigger to five steps.

- 1) Remove the fixing screw of the trigger on the back of the transmitter.
- 2) Adjust the angle by changing the direction of the angle spacer to have an angle easy to operate.
- 3) Once the trigger angle is set, fix the fixing screw of the trigger on the back of the transmitter.

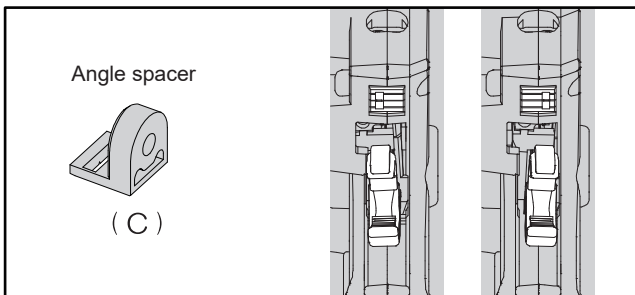
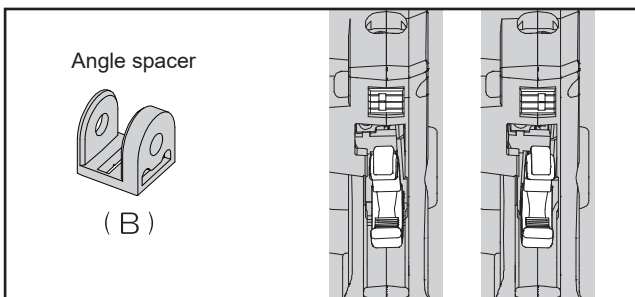
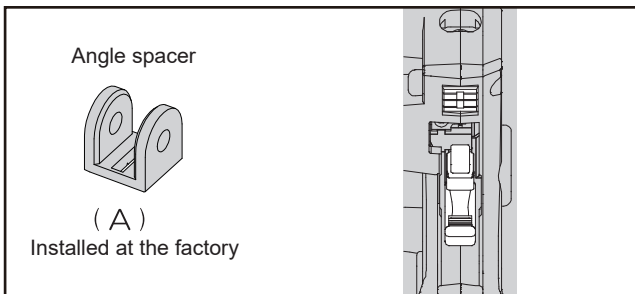
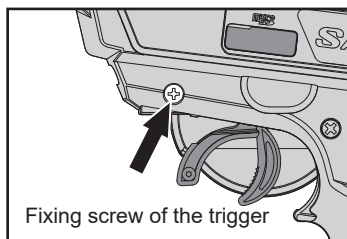

Adjustment of Brake Trigger

You can adjust trigger position according to your fingers by replacing brake trigger included. Standard Size, +1 Size, and +2 Size is included.

- 1) Remove the brake trigger fixing screw.
- 2) Select Brake Trigger according to your fingers.
- 3) Fix the brake trigger by the screw.

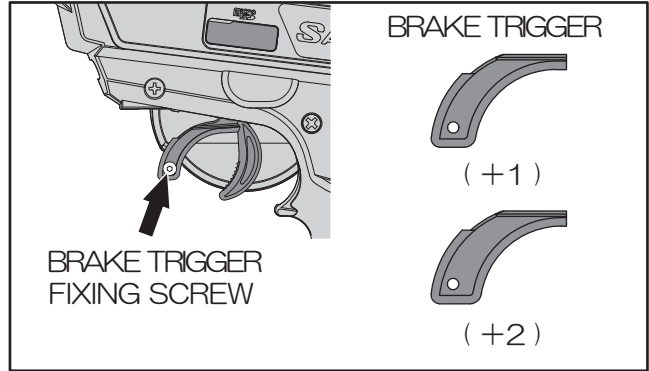

About the power source

How to place the transmitter batteries

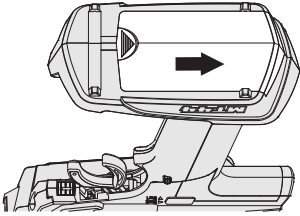

- ① Open the battery compartment cover by sliding the cover to the direction of the arrow while pressing it lightly.

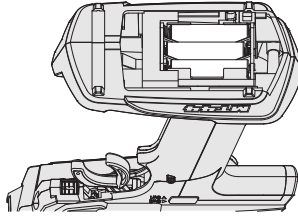

- ② Place 3 size AAA batteries. Make sure to observe correct polarities.

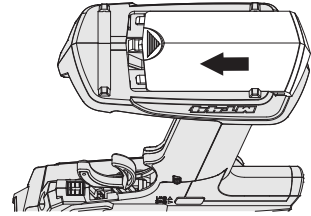

- ③ Align the convex part of the battery compartment cover and the groove of the battery compartment, slide the cover to the direction of the arrow and close tightly.

About the optional battery

- When using an optional battery, you can access to the charging port on the side of the battery from the connector cover.

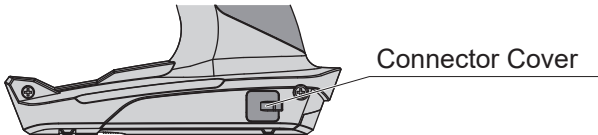

About Micro SD Card

- MT-44 is compatible to Micro SD Cards. By using a Micro SD Card, it is possible to save model data and telemetry data. Also, it is possible to do firmware update using a Micro SD Card when a firmware update of MT-44 is released.
- After inserting micro SD card into MT-44, the file named "MT-44" is made and the folder named "MODEL" is made. The model data is saved in the folder. If the log data is exported, the folder named "Log" is made and the data named "csv" is saved in the folder.

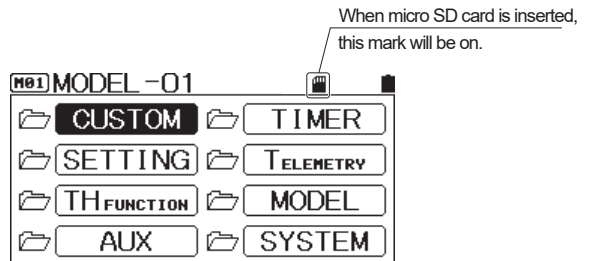
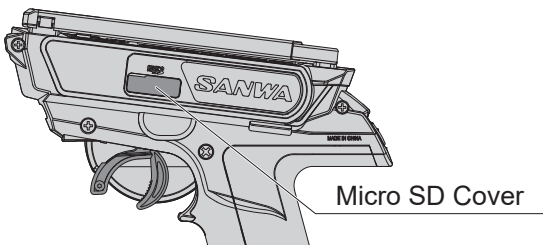

About connection and installation of the receiver

About the receiver

●RX-471(Example)

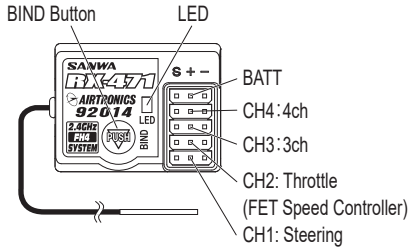

Condition of the Receiver LED

When receiving a signal	Blue light is on
When it cannot receive a signal	—
while setting up BIND	Blue light flashes. Blue light flashes rapidly.
Battery Fail Safe Operation is launched	Blue and Red lights are on.
After Battery Fail Safe Operation is launched, it becomes unable to receive a signal.	Red light is on.

About handling the Antenna

- Reception distance may vary depending on the location where the receiver and the antenna are installed.
- To protect the reception part (3 cm from the top) of the antenna, make sure to place the antenna in the antenna pipe as shown in the right illustration so that the top of the antenna is not exposed outside of the antenna pipe.
- Don't bend the antenna reception part or the antenna coaxial cable because breaking can occur inside.
- Don't pull the coaxial cable forcefully. It may damage the receiver interior.
- Install the antenna on an RC car so that the antenna reception part is in as high place as possible.
- Don't cut or bind the antenna reception part or the antenna coaxial cable since the receiver sensitivity might decrease.
- Keep the receiver antenna away from the motor and the FET Speed Controller (including cables) and raise it straight.

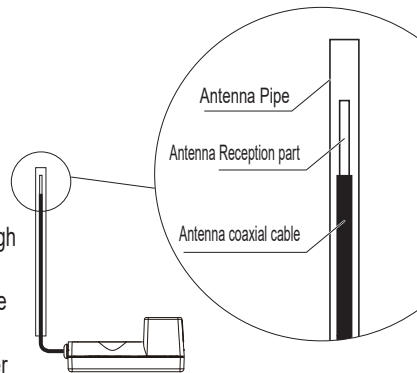

About built-in antenna receiver

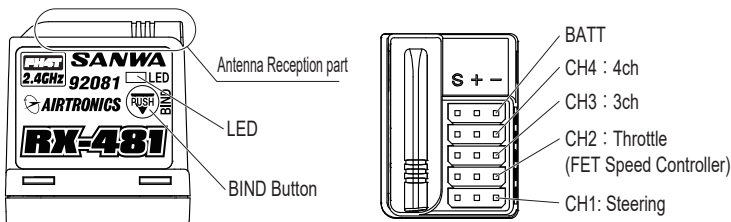

- Reception distance may vary depending on the location where the Antenn Reception part is installed.
- Install the antenna so that the antenna reception part in the above illustration is as high as possible.

About connection setup

● Connect the receiver and servos as shown in the illustration below.

• Connection example when used on an EP car

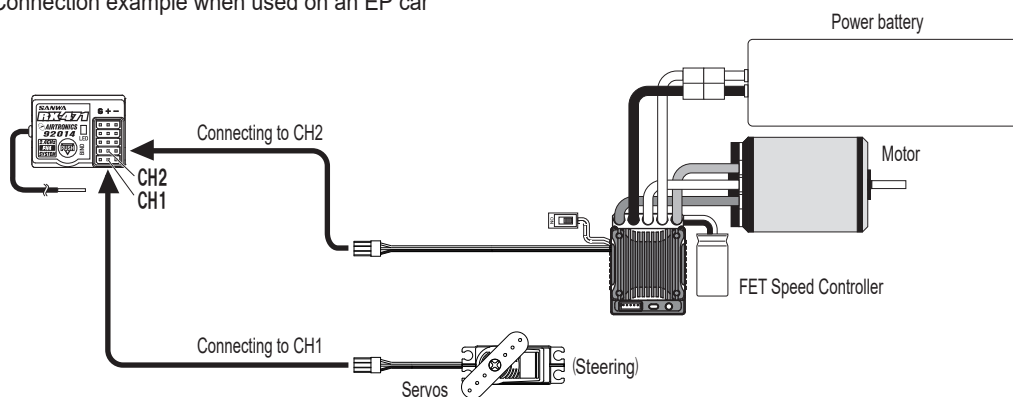

• Connection example when used on a GP (engine) car

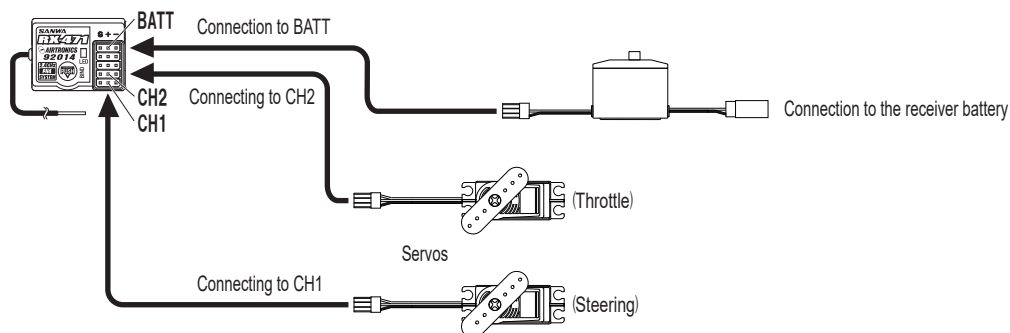

! Note

- If the connector is disconnected due to a vibration during operation, it can cause runaway. Connect the connector of the receiver, servos and switches securely.
 - Because the receiver is susceptible to vibration, impact and water, make sure to take measures for vibration-proof and waterproof. Negligence of taking these measures can cause runaway.
 - When installing the receiver, keep the receiver away from a carbon chassis and metallic chassis.
 - If metal parts installed on an RC car touch each other, it can cause noise that affects reception performance and it can cause runaway.
 - Make sure to install a noise killer condenser on the brush motor for electric RC cars. Without a noise killer condenser, it can cause noise and runaway.
 - For R/C System parts such as the transmitter, receiver, servos, FET Speed Controller and transmitter battery, use genuine SANWA products.
- ※ When combining products other than genuine SANWA products, modifying, adjusting or exchanging parts is done at a place other than SANWA, we do not take any responsibility.

Usage of each feature

About Key operation

- The user can set up and make a calling easily with the Multi-Selector and Select button/Back button.

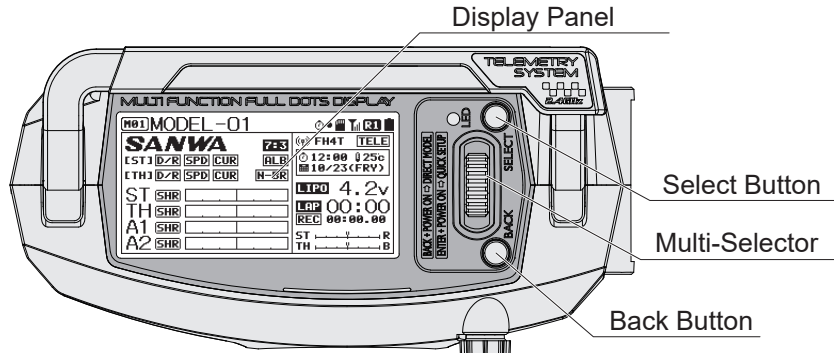

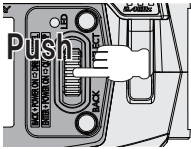
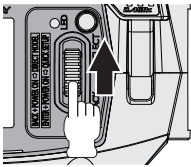
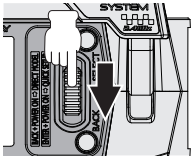
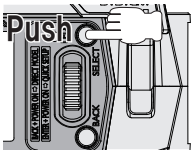
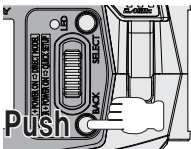
Key operation	Names	Performance
	Enter	<ul style="list-style-type: none"> ● Moves to the setup screen from the top screen. ● Selects a feature and item to set. ● By long pressing the button, the setting goes back to default.
	Multi-Selector Up	<ul style="list-style-type: none"> ● The cursor moves upward. ● The set value increases.
	Multi-Selector Down	<ul style="list-style-type: none"> ● Moves the cursor downward. ● The set value decreases.
	Select	<ul style="list-style-type: none"> ● Selects a channel or feature.
	Back/Cancel	<ul style="list-style-type: none"> ● Goes back to one step before. ● Cancels the setting.

About Power On Alarm

- MT-44 displays "No Operation" with a warning alarm after 10 minutes of no operation of the steering wheel, throttle trigger and switches. Alarm is turned off, if the steering wheel, throttle trigger or a switch is operated. In case you do not use them, turn the power switch off.

About the Display Panel

- Each feature of MT-44 allows you to directly select a feature with the Multi-Selector.
- You can set up each channel feature separately.
- As you turn the power switch on, the top screen launches after the boost screen is displayed (when the boot setting is on).

When changing each setting, select the menu by operating the Multi-Selector.

Top Screen

Labels: Name, Model Number, Effect Indicator, Log, Timer, Micro SD card, Telemetry, Racing Mode, Battery Indicator, Clock, If effect or function is active, icon will be displayed, Timer, Log Timer, Trim.



As you move up/down with the Multi-Selector, it becomes a toggle between Top Screen/Telemetry Screen.

Telemetry Screen

Each Telemetry data

By connecting each sensor to RX461 or RX462, using combination of RX461/RX462 and SUPER VORTEX or SV-PLUS series, and turning the Telemetry feature on, data is sent to the transmitter and it is displayed on the Telemetry Screen.

Menu Window
 •Select the Menu (Screen example)
 *Enter operation from the Top Screen

Usage of each feature

About the Menu structure

- The user can set up features and do model memory call easily by using each key.
- The Menu consists of Setting, AUX, Model, Timer, Telemetry and System Menu, and related features are included in each menu.

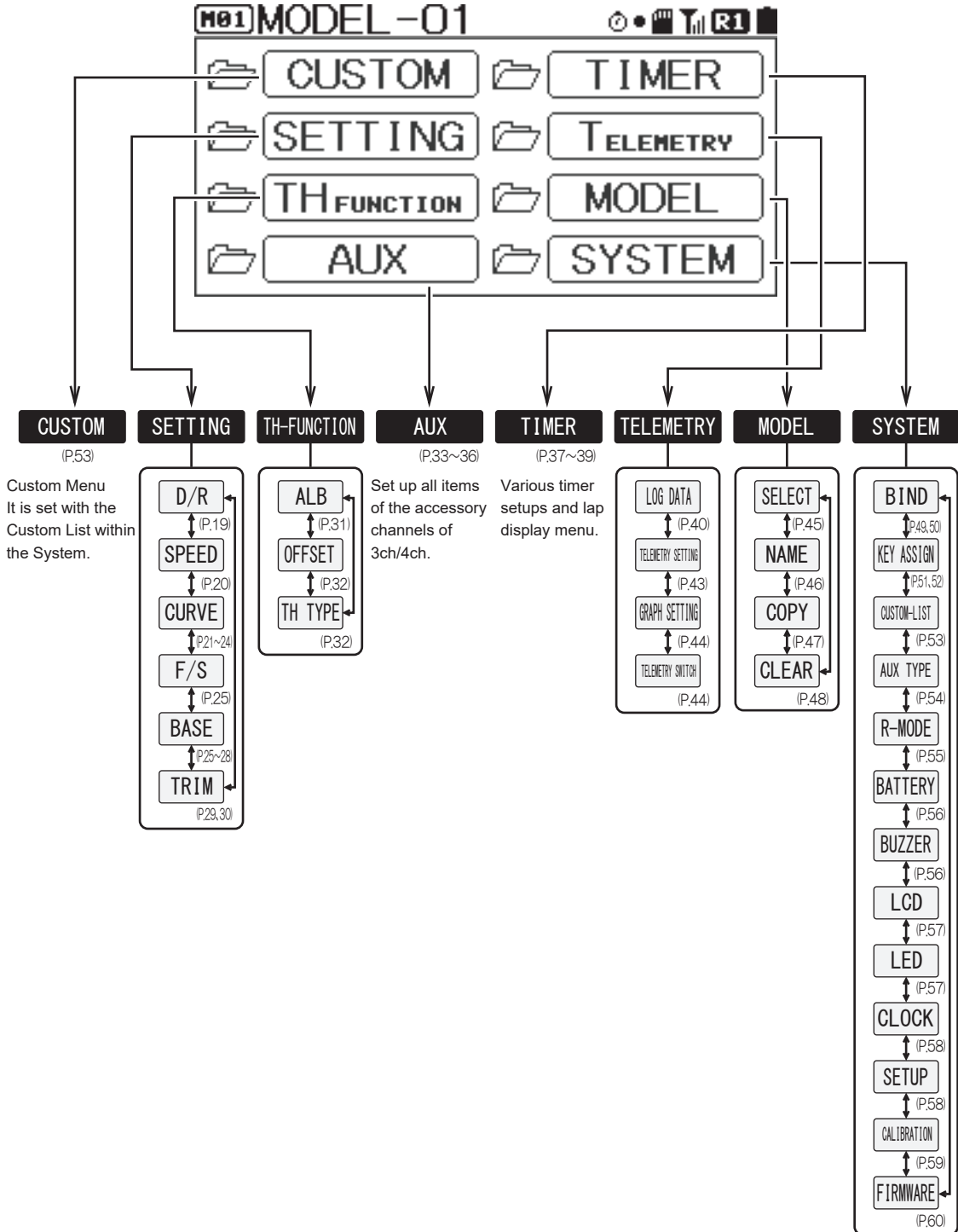

About Short Cut Menu

MT-44 has a feature of Short Cut Menu that is launched as the user performs key operation when operating the power switch.

If you turn the power switch on while pressing the Back Button, it becomes the Direct Model Select and if you turn the power switch on while doing Enter operation, the Quick Setup feature launches.

Direct Model Select is a feature for quickly selecting a model to run and Quick Setup is a feature for various setup with easy operation when setting up a new RC car.

Quick Setup feature is set in the following order using the Enter operation after launching. Selecting Model → Selecting Type → Initializing Model → Selecting RF Modes → Selecting Response Mode → BIND → Setting Base

Direct Model Select < DIRECT MODE >

Direct Model Select

1) Turn the power switch on while pressing the Back button.

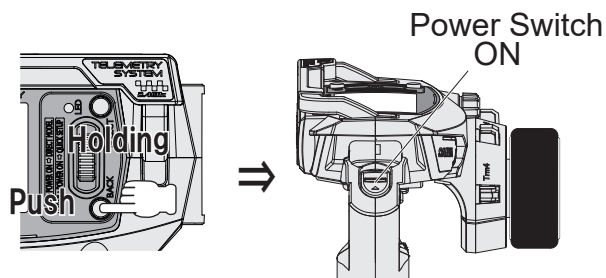

2) Selecting Model

Select a Model you wish to call with Multi-Selector.

Selection range: M01 ~ M20

3) Move the cursor to the Model you wish to call and do Enter operation. A message is displayed on the screen. Select a Model following the display.

① MODEL Selection Screen

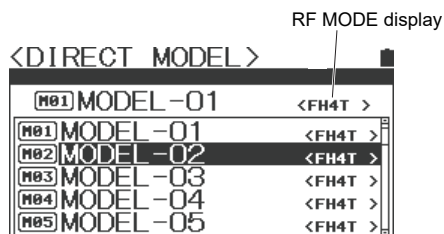

ENTER ↓ ↑ BACK

② Confirmation Screen

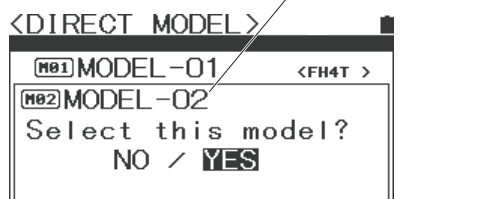

NO → Back to ①

YES → Change Model and move to the top.

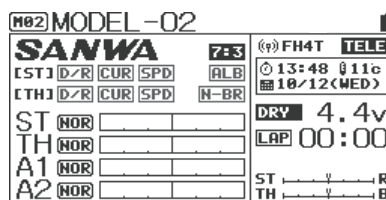

Usage of each feature

About Short Cut Menu

Quick Setup <QUICK SETUP WIZARD>

- Quick Setup

1) Turn the power switch on while doing Enter operation

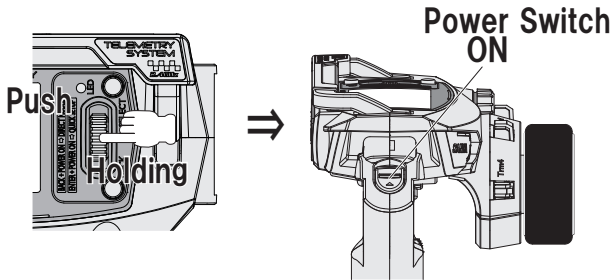

2) Quick Setup screen is displayed.

As you do Enter operation, Quick Setup Wizard is launched.

3) When the screen is changed to Model selection screen, select a Model to set up by using Multi-Selector.

When a Model to set is selected, set with Enter operation.

4) When the screen is changed to Car Type selection screen, select a Car Type using Multi-Selector.

When a Car Type is selected, set with Enter operation.

Setting up Type

- Setting range:
 - EP CAR STANDARD
 - EP CAR (LED UNIT)
 - EP CAR (SVZ)
 - EP CAR (SVD)
 - GP CAR STANDARD
 - 1/5 GP CAR DUAL BR1
 - 1/5 GP CAR DUAL BR2
 - CRAWLER 4WS/MOA
- Default: EP CAR STANDARD

*Channel operation of each type will be as follows.

Channel operation specifications for each Type

CH \ TYPE	EP CAR STANDARD	EP CAR (LED UNIT)	EP CAR (SVZ)	EP CAR (SVD)	GP CAR STANDARD	1/5 GP DUAL BR1	1/5 GP DUAL BR2	CRAWLER 4WS/MOA
CH1	STEERING	STEERING	STEERING	STEERING	STEERING	STEERING 1	STEERING	STEERING F
CH2	ESC	ESC	ESC	ESC	THROTTLE /BRAKE	THROTTLE /BRAKE R	THROTTLE	ESC F
CH3	AUX1	LED-ST	CODE1	CODE1	AUX1	STEERING 2	BRAKE R	STEERING R
CH4	AUX2	LED-TH	CODE2	CODE2	AUX2	BRAKE F	BRAKE F	ESC R

*Select a type to be used according to an RC.

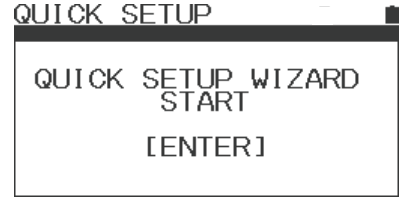

ENTER ↓ ↑ BACK

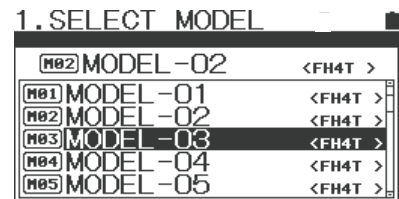

ENTER ↓ ↑ BACK

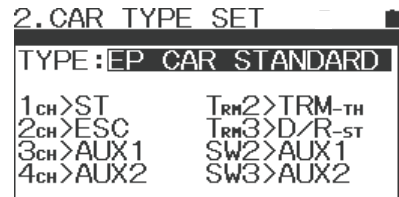

ENTER ↓ ↑ BACK

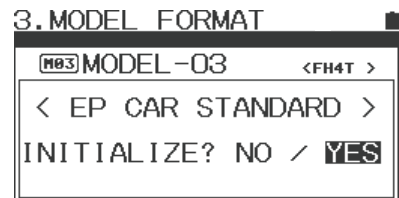

ENTER ↓ ↑ BACK

5) When deciding the car type using Enter, the screen changes to Initialization (Model Initialization) screen. Do initialization following the message.

6) When initializing (Initializing Model) is completed, the screen changes to RF Mode Selection Screen. Set RF Mode by using Up key/Down key and finalize with the Enter key for the receiver to be used.

- o Setting range: FH4T/FH3
- o Default: FH4T

• Compatible Receivers:

FH4T: RX-482, RX-481, RX-472, RX-471,
RX-47T, RX-462, RX-461,

SV-Plus Series

FH3: RX-451R, RX-451, RX-381, RX-380

7) Once RF Mode for the receiver is determined, the screen changes to the Response Mode screen. Set Response Mode according to the servos and the equipment to be used. Set with Up key/Down key and finalize with the Enter key.

- o Setting range: NOR (Normal/Analog Servos)
SHR (High Response/Digital Servos)
SSR (Super Response/SRG Servos)

- o Default: NOR (Normal/Analog Servos)

8) When Response Mode setting is completed, the screen changes to BIND Set up Screen. Follow the screen message and start Binding.

9) When Binding (BIND) is done, the screen changes to the Base Set Up screen. Complete setting for each channel (refer to P. 25-28).

10) When Base setting is done, Set Up Wizard will end. If you press the Enter button, the screen changes to the Top screen.

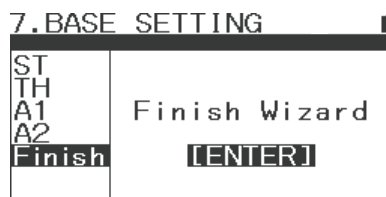
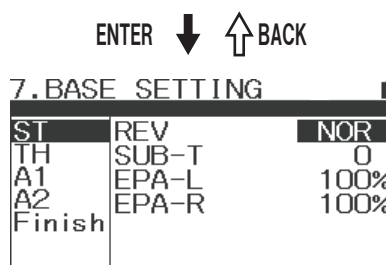
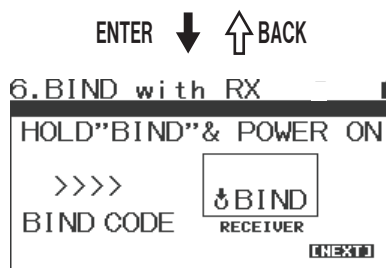
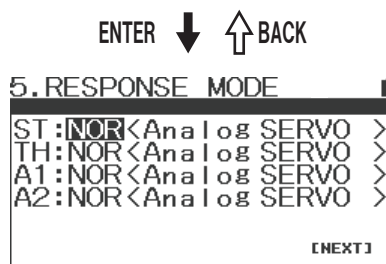
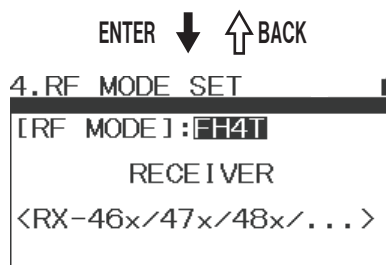

Important

- Please note that the analog servos do not work in SHR/SSR modes. If you mistakenly use the analog servos in SHR/SSR modes, it does not work normally and the servos will be broken. Never use analog servos in SHR/SSR modes. For digital servos (SRG, ERB, ERS Series and Digital ERG Series), either NOR or SHR mode works.
- SSR mode works only for SRG Servos, SUPER VORTEX/SV-PLUS series, HV-12, STOCK SPECIAL and HV-01.
- MT-44 will not be SSR mode by using RX-451R to BIND with SHR display. It works as the display shows.
- With SHR/SSR mode, BL-RACER, BL-FORCE, F2000, F2200, F3000, F3300, SBL-01, 02 and 03CL do not work. Make sure to use them in NOR mode.
- SV-08, HV-10, HV-12 and F2500 work in NOR/SHR modes.

Usage of each feature

Dual Rates [D/R]

SETTING

- You can adjust rudder angle when operating the steering wheel and throttle trigger to their peak. To correspond to the RC car or road condition, adjust the rudder angle as you operate.
*You can adjust steering for both right and left at the same time and throttle separately for high and brake sides. You can also adjust the brake side more precisely than adjusting with EPA.
- Don't increase the setting rate of dual rates (D/R) from the condition in which the linkage locks by operating the steering wheel and throttle trigger.
- You can also adjust more precisely by adjusting dual rates of the throttle side.
*When AUX1/AUX2 are set to CODE5/CODE10, setting change of D/R will not be reflected to the performance.

- Select features [ST/TH (H, L)/AUX1/AUX2] to adjust with the Select key.
- Determine the feature to adjust with the Enter key and adjust the setting rate with the multi-selector.
- Adjust the value of DUAL RATE by multi-selector.

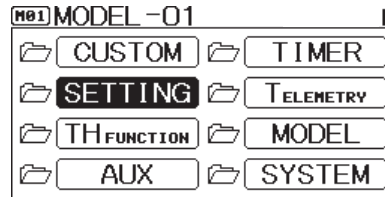

ENTER ↓ ↑ BACK

DUAL RATE SETTING SCREEN

Select Channel by Multi-selector button.

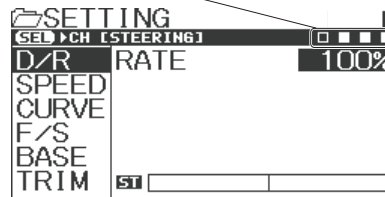

ENTER ↓ ↑ BACK

Steering Dual Rates Selection Screen

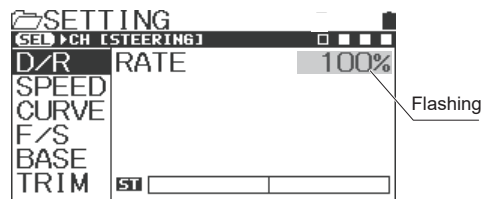

- During operation, the steering dual rates can be adjusted with Trim 3, brake dual rates can be adjusted with Trim 4. It's possible to assign other features to Trim 3 and Trim 4 with the key assign trim feature (P. 52).

*When cancelling a selected feature, operate the Back button.

- Setting range: ST/TH-H/AUX1/AUX2 : 0%~100%
- TH-L : 0%~120%
- Default: ST/TH/AUX1/AUX2 : 100%

Trim 4

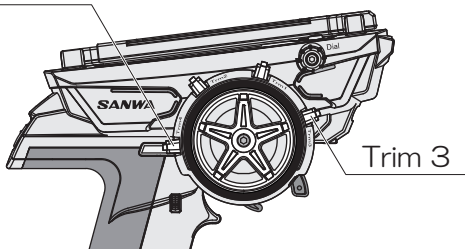

*Make sure that the servos do not lock to make clicking sound! Note)
The same for throttle.

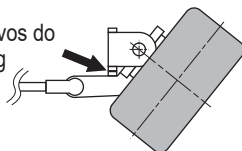

Note

- If the linkage is locked for a long period, it can cause the servo motor breakage.

Supplement

- Adjust the end point of the steering/throttle linkage before adjusting dual rates (P. 27, 28).

SPEED

SETTING

- Features to control the speed of the servos used for steering and throttle. By setting, the RC car is not affected even when doing a sudden operation. On the steering side, smooth corner work becomes possible and on the throttle side, stable rising from a corner by throttle work with saved power.
- * When setting AUX TYPE to [CODE5/CODE10], adjusting the speed feature of the AUX channel does not affect the performance.
- * When setting the speed of the AUX channel, do so using steering/throttle as a reference.

[ST] Steering Speed

- A feature to delay the speed of the steering servos against the steering operation. You can set speed for steering forward and returning individually. For steering operation slower than setting, the speed feature does not work.

- 1) Select [ST (Steering)] with Up key/Down key.
- 2) Setting on the forward side [FORWARD]
Select [FORWARD] with the Enter key and adjust the setting value with Up key/Down key.

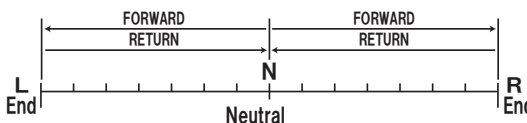

*When cancelling a selected feature, use the Back key.

- Setting range: 0~100
- Default: 0

- 3) Setting on the Return side (RETURN)
Select [RETURN] with the Enter key and adjust the setting value with Up

- Setting range: 0~100
- Default: 0

*Adjust during actual operation. When not using the features or when a setting value cannot be determined even after adjustment, set the value to 0% (linear).

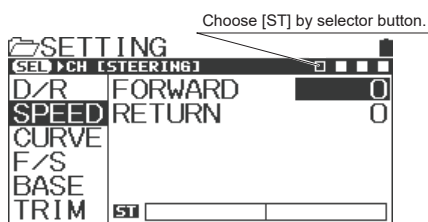

Supplement

- For driving an RC car, steering operation that suits the movement of the RC car is important and excessive operation is not recommended. Steering speed can minimize unnecessary operation and enables smooth cornering.
- When steering speed and steering curve are combined, the effect is doubled.

Usage of each feature

[TH] Throttle Speed

- A feature to slow down the performance speed of the throttle servos and delay the response of the speed controller against throttle operation. You can set speed for entering throttle (Forward) and returning (Return) individually. The speed feature does not work with throttle operation slower than the setting. *Setting is only for High side and Brake side cannot be set.

- 1) Select [TH (Throttle)] with Up key/Down key.
- 2) Setting on the forward side [FORWARD]
Select [FORWARD] with the Enter key and adjust the setting value with Up key/Down key.

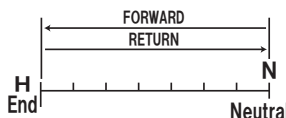

*When cancelling a selected feature, use the Back key.

- Setting range: 0~100
- Default: 0

- 3) Setting on the Return side (RETURN)
Select [RETURN] with the Enter key and adjust the setting value with Up key/Down key.

- Setting range: 0~100
- Default: 0

Choose [TH] by selector button.

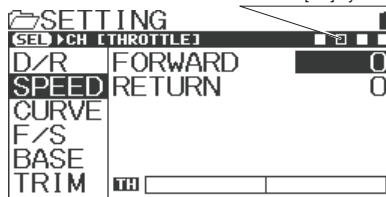

*Adjust during actual operation. When not using the features or when a setting value cannot be determined even after adjustment, set the value to 0% (linear).

Supplement

- For driving an RC car, throttle operation that suits the movement of the RC car is important and excessive operation is not recommended. Throttle speed can minimize unnecessary operation and enables smooth performance.
- When throttle speed and throttle curve are combined, the effect is doubled.

Usage of each feature

Curve [CURVE]

Setting/SETTING

- Features to change the operating quantity of the servos again st operation of the steering wheel/throttle trigger. When the setting value is on the plus (+) side, it responds quickly, when on the minus side (-), it responds mildly.
- You can select a curving movement exponential (EXP) and a linear movement adjustable rate control (ARC).
- * When setting AUX TYPE to [CODE], adjusting the curve feature of the AUX channel does not affect the performance. When setting curve for the AUX channel, do so using steering/throttle as a reference.

• Exponential (EXP)

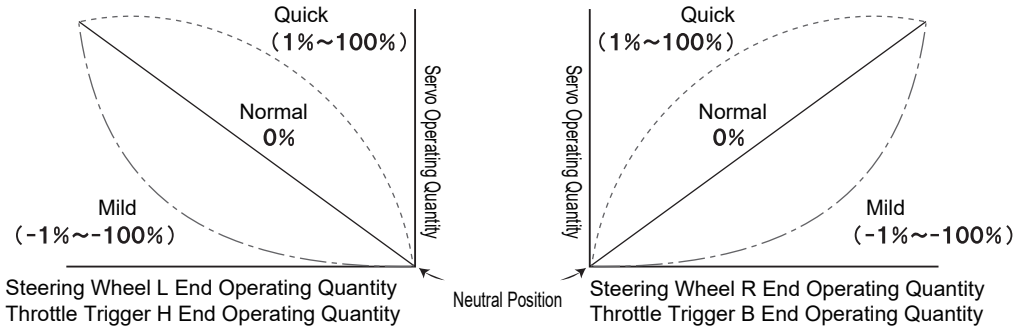

• Adjustable Rate Control (ARC)

You can change the position where operation is changeable by adjusting the setting of POINT.

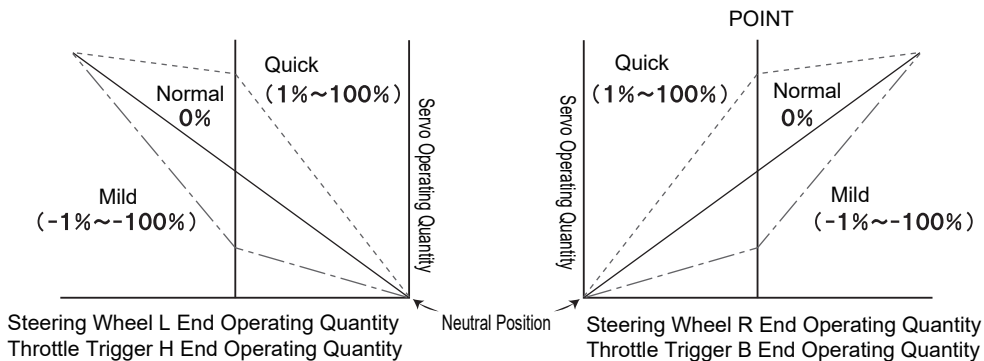

[ST] Steering Exponential

- You can change the steering feature from Mild to Linear to Quick. In general, if you find your RC car oversteering, change the setting to the minus side and if you find under steering, change to the plus side. Steering Exponential is a simultaneous setting for L and R.

1) Select ST with the Select button and set CURVE TYPE of ST to [EXP] with the multi-selector.

2) Adjust the setting value with the multi-selector.

- Setting range: -100%~100%
- Default: 0%

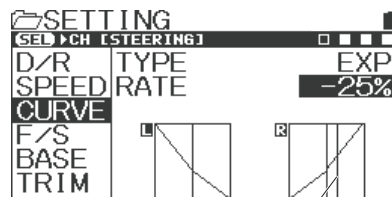

*When cancelling a selected feature, use the Back button.

Steering Operation Position

[TH] Throttle Exponential

- You can change the throttle feature from Mild to Linear and to Quick. In general, when operating on a slippery road or if you find over powering, change the setting to the minus side and when operating on a high-grip road or if you find lack of power in the power unit, change to the plus side. You can set the High side and the brake side separately.

*Selection of the High side and the brake side is done by trigger operation.

- Select TH with the Select button and set CURVE TYPE of TH to [EXP] with the multi-selector.
- Adjust the setting value with the multi-selector.

- Setting range: -100%~100%
- Default: 0%

Select H/B by trigger operation.

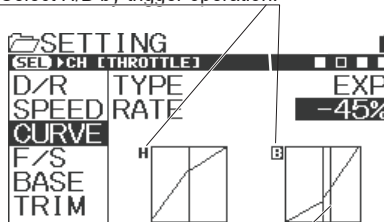

Throttle Operation Position

[AUX1] AUX1 • Exponential

- You can change the operation feature of AUX1 from Mild to Linear to Quick. You can set the High end and the Low end separately.

*When setting AUX1 to [CODE5/CODE10] in AUX TYPE, changing the setting does not affect the performance.

- Select AUX1 with the Select button and set CURVE TYPE of AUX1 to [EXP] with the multi-selector.
- Adjust the setting value with the multi-selector.

- Setting range: -100%~100%
- Default: 0%

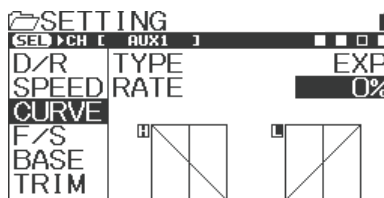

[AUX2] AUX2 • Exponential

- You can change the operation feature of AUX2 from Mild to Linear and to Quick. You can set the High end and the Low end separately.

*When setting AUX2 to [CODE5/CODE10] in AUX TYPE, changing the setting does not affect the performance.

- Select AUX2 with the Select button and set CURVE TYPE of AUX2 to [EXP] with the multi-selector.
- Adjust the setting value with the multi-selector.

- Setting range: -100%~100%
- Default: 0%

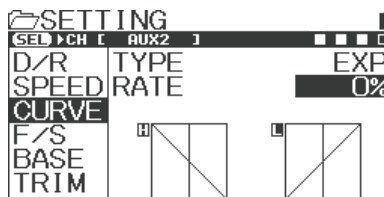

Usage of each feature

CURVE

SETTING

[ST] Steering Adjustable Rate Control

- You can change the steering feature from Mild to Linear and to Quick. In general, if you find your RC car oversteering, change the setting to the minus side and if you find understeering, change to the plus side. Steering Adjustable Rate Control is a simultaneous setting for L and R.

1) Select ST with the Select button and set CURVE TYPE of ST to [ARC] with the multi-selector.

2) Setting Rate [RATE]

Select [RATE] with the multi-selector and adjust the setting value.

- Setting range: -100%~100%
- Default: 0%

3) Setting Point [POINT]

Select [POINT] with the multi-selector and adjust the setting value.

- Setting range: 5%~95%
- Default: 0%

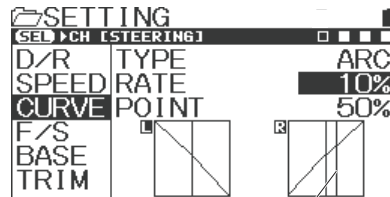

Steering Operation Position

* When cancelling a selected feature, use the Back button.

[TH] Throttle Adjustable Rate Control

- You can change the throttle feature from Mild to Linear and to Quick. In general, when operating on a slippery road or if you find over powering, change the setting to the minus side and when operating on a high-grip road or if you find lack of power in the power unit, change to the plus side. You can set the High side and the brake side separately.

*Selection of the High side and the brake side is done by trigger operation.

1) Select TH with the Select button and set CURVE TYPE of TH to [ARC] with the multi-selector.

2) Setting Rate [RATE]

Select [RATE] with the multi-selector and adjust the setting value.

- Setting range: -100%~100%
- Default: 0%

3) Setting Point [POINT]

Select [POINT] with the multi-selector and adjust the setting value.

- Setting range: 5%~95%
- Default: 50%

Select H/B by trigger operation.

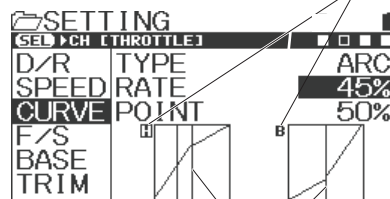

Point Setting Position

* When cancelling a selected feature, use the Back button.

[AUX1] AUX1 Adjustable Rate Control

- You can change the AUX1 performance feature from Mild to Linear and to Quick. You can set the High side and the Low side separately.

*When setting AUX1 to [CODE5/CODE10] in AUX TYPE, changing the setting does not affect the performance.

- 1) Select AUX1 with the Select button and set CURVE TYPE of AUX1 to [ARC] with the multi-selector.

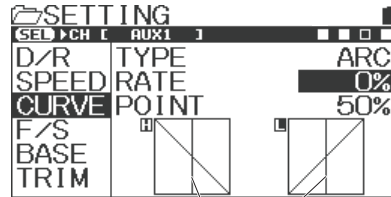

Point Setting Position

- 2) Setting Rate [RATE]
Select [RATE] with the multi-selector and adjust the setting value.

- Setting range: -100%~100%
- Default: 0%

- 3) Setting Point [POINT]
Select [POINT] with the multi-selector and adjust the setting value.

- Setting range: 5%~95%
- Default: 0%

*When cancelling a selected feature, use the Back button.

[AUX2] AUX2 Adjustable Rate Control

- You can change the operation feature of AUX2 from Mild to Linear and to Quick. You can set the High side and the Low side separately.

*When setting AUX2 to [CODE5/CODE10] in AUX TYPE, changing the setting does not affect the performance.

- 1) Select AUX2 with the Select button and set CURVE TYPE of AUX2 to [ARC] with the multi-selector.

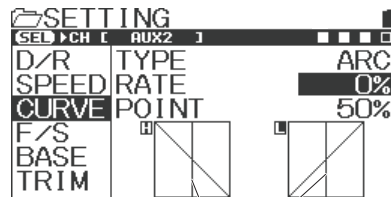

Point Setting Position

- 2) Setting Rate [RATE]
Select [RATE] with the multi-selector and adjust the setting value.

- Setting range: -100%~100%
- Default: 0%

- 3) Setting Point [POINT]
Select [POINT] with the multi-selector and adjust the setting value.

- Setting range: 5%~95%
- Default: 0%

*When cancelling a selected feature, use the Back button.

Usage of each feature

Fail Safe [F/S]

SETTING

- Fail Safe Operation is a feature to keep the servos in a predetermined position for each channel in the event that the receiver cannot receive a signal from the transmitter. A feature to keep the servos in a predetermined position for the servo of the throttle channel (2ch) in the event that the battery voltage on the receiver side of an engine RC car goes below the set voltage is Battery Fail Safe Operation.
 - Battery Fail Safe Operation cannot be set when the throttle channel (2ch) is set to FREE/HOLD (*Battery Fail Safe Operation works only for the throttle channel).
- *Don't use Battery Fail Safe Operation feature for electric RC cars.

1) Select F/S with the multi-selector and select a channel to set fail safe operation (ST/TH/AUX1/AUX2) with the select button.

- 2) Enter the set channel and operate the multi-selector.
The fail safe mode setting changes in order of FREE -> FS -> HOLD.
- Setting range: FREE/FS(100%~-100%)/HOLD
 - Default: FREE

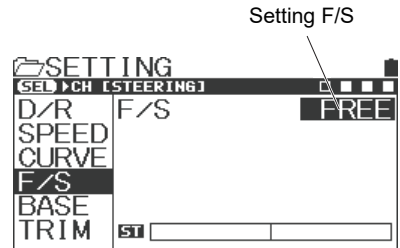

*About each mode

FREE (Free Mode): When the receiver cannot receive the signal from the transmitter, the signal output to the servo stops and the servo will be free.

FS (Fail Safe Mode): When the receiver cannot receive the signal from the transmitter, the servo will be held in the set position.

HOLD (Hold Mode): The last position before the signal from the transmitter to the receiver is lost will be held.

- When the receiver can receive the signal from the receiver again, each mode of FREE/HOLD/FS is automatically released.

3) Setting the Fail Safe (FS)

Move to the position where the Fail Safe Operation is used. When the position is determined, long press the Enter key to set the position when the Fail Safe Operation works.

- * For safety reason, we recommend setting the throttle channel on the brake side when setting the Fail Safe.

4) Setting the Battery Fail Safe Operation

After setting the throttle channel position, move the cursor to [B-F/S] to set the voltage.

- Setting range: • For FH3: OFF, 3.5v ~ 5.0v (*Not compatible with Li-Po Battery)
- For FH4: OFF, 3.5v ~ 7.4v

- *The Battery Fail Safe Operation is a feature to activate Fail Safe Operation when the receiver battery voltage rises up to the set voltage on a GP car.
- Don't use the Battery Fail Safe feature on electric RC cars.

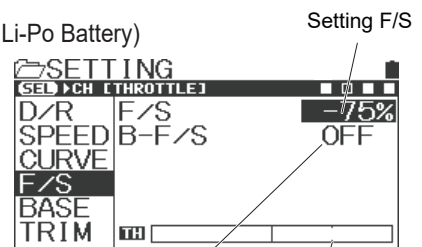

BATT-F/S Setting

F/S Setting Position

5) Checking the Fail Safe Operation

Turn off the power of the receiver while the Fail Safe Operation is set and check if the servo moves to the position where the Fail Safe Operation is set.

Important

- About the Fail Safe Operation
When the Fail Safe feature is on, check the setting of the Fail Safe before operating.
Don't change the setting of the Fail Safe during operation.

BASE

SETTING

- Base [BASE] is a feature to integrate features of the Reverse that determines the direction of the servo of each channel and the speed controller according to a specific RC car, the Sub Trim that adjusts the neutral position and the End Point Adjustment [EPA] that sets the operating quantity into one feature (Base) to allow you to make a setting all at once.

Reverse [REV]

- This is used when operation and the movement of the servo are reversed while operating Steering/Throttle/AUX1/AUX2.

1) Select BASE with the multi-selector and select a channel to set (ST/TH/AUX1/AUX2) with the select button.

2) Enter with the channel to be set and use the multi-selector. The Reverse setting will be changed.

* When cancelling a selected feature, use the Back key.

- Setting range: NOR/REV
- Default: NOR

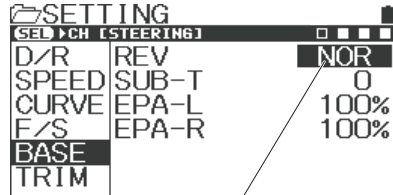

Setting REV

Sub Trim [SUB-T]

- Using the Sub Trim feature, correct the neutral (center) of Steering/Throttle/AUX1/AUX2 so that Trim can be used in the center position. When installing a servo on to an RC car, center the servo with Sub Trim first before adjusting End Point Adjustment.

1) Before using, center (0) each main trim.

2) Select SUB-T with the multi-selector and select a channel (ST/TH/AUX1/AUX2) to adjust Sub Trim with the select button.

3) Determine by Enter operation in the channel to set.

4) Install the servo horn (servo saver horn) as close to centered as possible.

* For installation position of the servo horn, follow the instruction on the car body side.

5) Use the multi-selector to adjust the center.

- Setting range: L150~R150(ST)
H150~B150(TH)
H150~L150(AUX1, AUX2)
- Default: 0

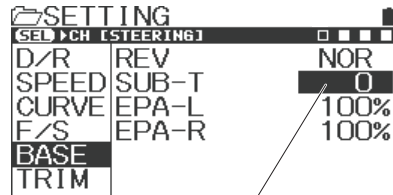

Setting SUB-T

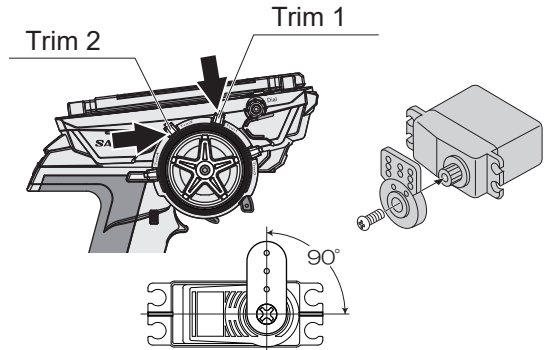

Note:

- When installing the servo horn onto your servo, fix the servo horn as close to the center as possible and center it with Sub Trim. If Sub Trim and the transmitter main trim are off to one side, it causes dead band (the range the servo does not move) to the steering wheel and the throttle trigger.

Important

- About Trim and Sub Trim

Trim is a feature for adjusting the neutral (center) position of the servo. When your model does not run straight after installing the steering servo onto the model, Trim adjusts the main trim of the steering. Also, the neutral position of the carburetor on RC cars needs neutral adjustment of the throttle servo along with linkage adjustment after installing the servo. Neutral position adjustment is necessary not only after installing the servo but for changes that happen during running such as tire wears and chassis twist. MT-S Trim features two types of Trim including Center Trim that adjusts only the neutral position without changing the end of the operating angle and Parallel Trim that moves the end of the operating angle and the neutral position simultaneously. Sub Trim that adjusts the neutral (center) position before fixing the servo horn is Parallel Trim and the main trim is Center Trim.

○Center Trim (Main Trim)

Even if you move the neutral position with Trim, the end of the operation angle does not move.

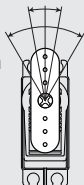

○Parallel Trim (Sub Trim)

When you move the neutral position with Trim, the end of the operation angle also moves. When Sub Trim is adjusted after linkage is completed, readjustment of End Point Adjustment (EPA) will be necessary.

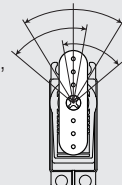

Usage of each feature

Usage of each feature

BASE

SETTING

- Base [BASE] is a feature to integrate features of Sub Trim that adjusts the direction of the servo of each channel and the speed controller according to a specific RC car and the End Point Adjustment [EPA] that sets the operating quantity into one feature (Base) to allow you to make a setting all at once.

End Point Adjustment [EPA]

- You can adjust left and right operating quantity of the steering servo when operating the steering wheel/throttle trigger and operating quantity of the high side and the brake side of the throttle servo, and the servo operating quantity of AUX1, AUX2 (3ch, 4ch).

[ST-EPA] Steering End Point Adjustment

- Due to linkage, suspension balance and the difference of the tire diameter, left and right cornering radius can be different. In case of this, this feature adjusts the servo operating quantity of left and right so that left and right cornering radius can be the same.

- 1) Before adjusting Steering End Point Adjustment (ST-EPA), make a neutral adjustment of the servo (P.26).
 - Neutral adjustment is to align the center position with Sub Trim by turning the power on and installing the servo horn in the approximate center position.

- 2) Select either of [EPA-L/EPA-R] with the multi-selector and determine with the Enter.
- 3) Adjust the operating quantity with the multi-selector.

*When the cursor is on either of EPA-L/EPA-R, it is also possible to move the cursor by steering operation.

*Make sure the servos do not lock to make clicking sound!

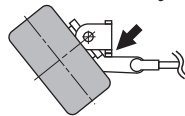

- Setting range: L/R 0~150%
- Default: L/R 100%

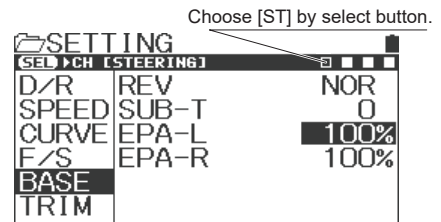

Note If the linkage is locked for a long period, it can cause the servo breakage.

[TH-EPA] Throttle End Point Adjustment

- It adjusts the High Point of FET Speed Controller, Brake Point, carburetor of engine cars and the brake operating quantity.

- 1) For an engine car, make a neutral adjustment of the servo (P.16) before adjusting the Throttle End Point Adjustment (TH-EPA),
 - Neutral adjustment is to align the center position with Sub Trim by turning the power on and installing the servo horn in the approximate center position.
- 2) Select [TH/Throttle] with the Select button.

- 3) Select either of [EPA-H/EPA-B] with the multi-selector and determine with the Enter.

- 4) Adjust the operating quantity with the multi-selector.

When adjusting FET Speed Controller, normally set both the high side and the brake side to 100% and set neutral, high point and brake point on the FET Speed Controller side (Setting method is different depending on the FET Speed Controller).

* When the cursor is on either of EPA-H/EPA-B, it is also possible to move the cursor by trigger operation.

- Setting range: H/B 0~150%
- Default: H/B 100%

*Make sure the servos do not lock to make clicking sound!

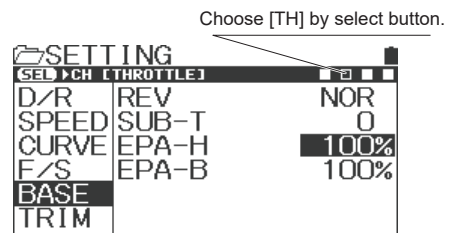

Note When EPA setting value is too large on the fully open side of the carburetor and the brake side for throttle linkage, the servo is locked and it can cause the motor malfunction and runaway.

[AUX1-EPA] AUX1 End Point Adjustment

- You can use AUX1 for functions of accessories and adjust the maximum steering angle (operating quantity) with EPA. Since you can set H/L separately, precise adjustment is possible.
- *When setting AUX1 to [CODE5/CODE10] in AUX TYPE, the operation will not be reflected even by adjusting EPA.

- 1) Before adjusting AUX1 End Point Adjustment (AUX1-EPA), make a neutral adjustment of the servo (P. 26).
 - Neutral adjustment is to align the center position with Sub Trim by turning the power on and installing the servo horn in the approximate center position.
- 2) Select [AUX1] with the Select button. Select either of [EPA-H/EPA-L] with the multi-selector and determine with the Enter.

Choose [AUX1] by select button.

SETTING		
SEL	CH	
	AUX1	1
D/R	REV	NOR
SPEED	SUB-T	0
CURVE	EPA-H	100%
F/S	EPA-L	100%
BASE		
TRIM		

- 3) Adjust the operating quantity with the multi-selector.

- Setting range: H/L 0~150%
- Default: H/L 100%

[AUX2-EPA] AUX2 End Point Adjustment

- You can use AUX2 for functions of accessories and adjust the maximum steering angle (operating quantity) with EPA. Since you can set H/L separately, precise adjustment is possible.
- *When setting AUX2 to [CODE5/CODE10] in AUX TYPE, the operation will not be reflected even by adjusting EPA.

- 1) Before adjusting AUX2 End Point Adjustment (AUX2-EPA), make a neutral adjustment of the servo (P. 26).
 - Neutral adjustment is to align the center position with Sub Trim by turning the power on and installing the servo horn in the approximate center position.
- 2) Select [AUX2] with the Select button. Select either of [EPA-H/EPA-L] with the multi-selector and determine with the Enter.

Choose [AUX2] by select button.

SETTING		
SEL	CH	
	AUX2	1
D/R	REV	NOR
SPEED	SUB-T	0
CURVE	EPA-H	100%
F/S	EPA-L	100%
BASE		
TRIM		

- 3) Adjust the operating quantity with the multi-selector.

- Setting range: H/L 0~150%
- Default: H/L 100%

Usage of each feature

TRIM

SETTING

- For Trim, you can adjust Trim for each channel and set the Trim action (center/parallel).

TRIM

- Correct neutral (center) of each channel (ST/TH/AUX1/AUX2) with Trim.
 - As default, steering is set for Trim 1 (TRM1), and throttle for Trim 2 (TRM2).
- 1) Select a channel (ST/TH/AUX1/AUX2) for adjusting Trim with the Select button.
 - 2) Determine with Enter operation and adjust with the multi-selector.

Selecting a channel with the Select button

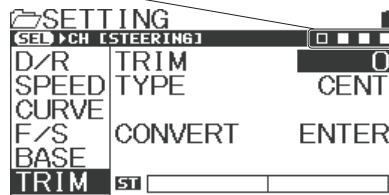

- Setting range: ST: L100~R100
TH: H100~B100
AUX1: H100~L100
AUX2: H100~L100

- Default: ST: 0
TH: 0
AUX1 : 0
AUX2 : 0

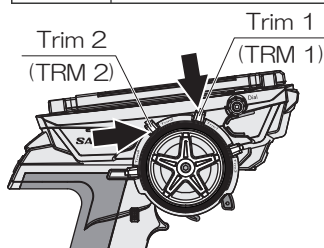

- *Make an adjustment with TRM1 (ST) and TRM2 (TH) during operation. You can change the Trim lever position with the Key Assignments Trim feature (P. 52).

Important

•About Trim

- Trim is a feature to adjust the neutral (center) position of the servos.
- After installing the steering servo onto a car, you can adjust with Trim when the car does not move straightly.
- Neutral position adjustment is necessary not only after installing the servo but for changes that happen during running such as tire wears and chassis twist.
- It's Sub Trim that adjusts the center position when adjusting linkage (P. 26)



- If Trim and Sub Trim are off to one side, it causes dead band (the range the servo does not move) to the steering wheel and the throttle trigger. When installing the servo horn, fix the servo horn as close to the center as possible and center it with Sub Trim.

TRIM TYPE

- You can set Trim performance of each channel to Center Trim (CENT) and Parallel (PARA).
- As default, steering is set for Trim 1 (TRM1), and throttle for Trim 2 (TRM2).

- 1) Select a channel (ST/TH/AUX1/AUX2) to set with the Select button.

Selecting a channel with the Select button

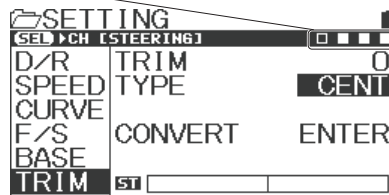

- 2) Determine with Enter operation and adjust with the multi-selector.

- Setting range: CENT (Center Trim)/PARA (Parallel Trim)

- Default: CENT (Center Trim)

Important

•About Center Trim and Parallel Trim

There are two types of Trim including Center Trim that adjusts only the neutral position without changing the end of the operating angle and Parallel Trim that moves the end of the operating angle and the neutral position simultaneously. Sub Trim that adjusts the neutral (center) position before fixing the servo horn is Parallel Trim and the main trim has options of Center Trim and Parallel Trim. You can select according to your purpose.

◦Center Trim

Even if you move the neutral position with Trim, the end of the operation angle does not move.

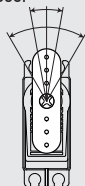

◦Parallel Trim

When you move the neutral position with Trim, the end of the operation angle also moves. When Sub Trim is adjusted after linkage is completed, readjustment of End Point Adjustment (EPA) will be necessary.

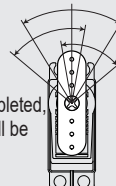

CONVERT

●A feature to convert Trim that has been adjusted in each channel to Sub Trim and EPA and to correct Trim to center. Depending on a setting, there is a case you cannot convert.

- 1) Select a channel (ST/TH/AUX1/AUX2) to convert with the Select button.
- 2) Once a channel to set is determined, launch the convert feature with Enter operation.
- 3) For example, if the converting feature is used when Steering Trim is [L20] and each [EPA] is 100%, the flow will be as shown in right illustration. Trim will be centered [0] and the portion of the Trim movement will be converted to Sub Trim and EPA.

*Conversion can be set in each channel.

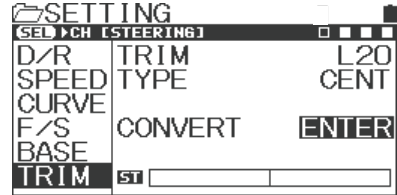

ENTER ↓ ↑ BACK

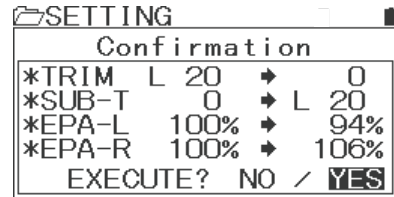

ENTER ↓ ↑

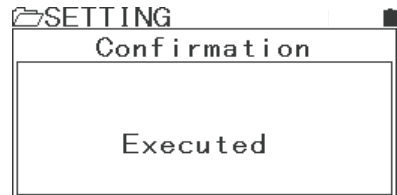

Conversion is completed. ↓↓

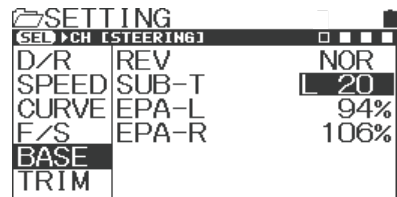

Usage of each feature

THROTTLE FUNCTION / TH-FUNCTION

- The throttle function allows you to adjust the setting values of ALB (Anti-Lock Brake), OFFSET and TH TYPE (throttle type) of the throttle channel.

Anti-Lock Brake [ALB]

THROTTLE FUNCTION/TH-FUNCTION

- Anti-Lock Brake enables stable braking on a low grip road.
- Because of the stable braking, you can trace cornering lines as intended.

- 1) Select the throttle function with the multi-selector and determine with the Enter operation.
- 2) When selecting [ALB] with the multi-selector and determining with the Enter, the menu changes to ALB setup menu.
- 3) Setting Stroke (STROKE)
Set Stroke of ALB with the multi-selector.
Stroke is the width of repeated actions at the time of braking.

- Setting range OFF, 0~100%
- Default OFF *OFF ALB does not work when it is off.

- 4) Setting Point (POINT)
Set Point of ALB with the multi-selector.
Point is the position where ALB starts acting when operating the brake.

- Setting range: 5%~100%
- Default: 80%

- 5) Setting Lag (LAG)
Set Lag of ALB with the multi-selector.
Lag is a setting of time lag from the time when operating to the point to the time when ALB starts acting.

- Setting range: 0.00s~1.00s
- Default: 0.00s

- 6) Setting Cycle (CYCLE)
Set a cycle of ALB with the multi-selector.
Cycle is a frequency setting of repeated actions for braking.

- Setting range: 0.01s~1.00s
- Default: 0.08s

- * When Anti-Lock Brake is working, X illumination and Function LED flash.

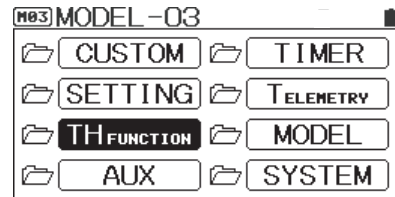

ENTER ↓ ↑ BACK



ENTER ↓ ↑ BACK

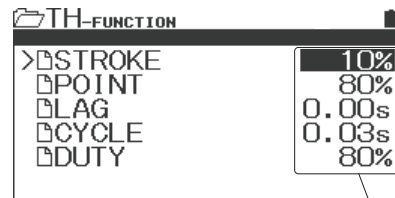

Set each Parameter.

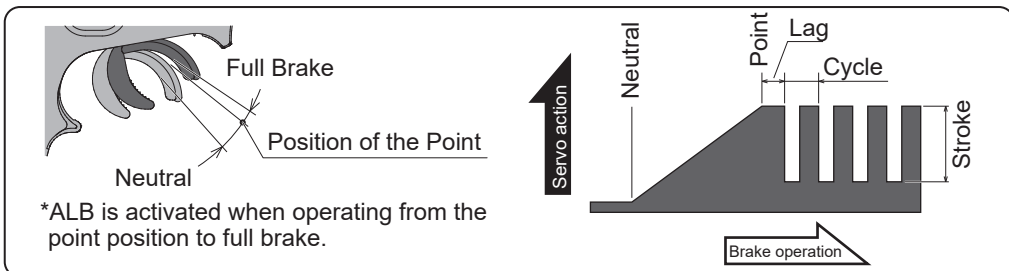

! Supplement

- Activate the brake rather strongly not to the extent that the tires of your RC car lose their grips (not to slip) and adjust so that Anti-Lock Brake is activated just before the tires are locked and slide.
- If you set ALB using a speed controller with a back on an RC car, you may not be able to operate back movement. When using a back movement, turn ALB off.

OFFSET

THROTTLE FUNCTION/TH-FUNCTION

- By moving the position of the throttle neutral at the time of starting an engine RC car engine, it improves the start-up performance of the engine.
- You can fix at a position where idling speed is increased so that the engine will not stop during refueling your engine RC car.
- By operating the switch that has been set, you can stop the engine of your RC boat.
- You can use various power sources with Offset feature.
- ON/OFF of the Offset feature is not assigned to the switch and keys at the factory.
When using, assign the features with key assignment (P. 51, 52)

- 1) Select the throttle function with the multi-selector and determine with the Enter operation.
- 2) Select [OFFSET] with the multi-selector and determine with Enter.
It will change to OFFSET Setting menu.
- 3) Setting Offset [OFFSET]
Set ON/OFF of the Offset feature with the multi-selector.

- Setting range: ON/OFF
- Default: OFF

- 4) Setting Type [TYPE]
Set Type of the Offset with the multi-selector.

- Setting range: I-UP (Idle Up)/N-BR (Neutral Brake)
- Default: I-UP

- 5) Setting Point [POINT]
Set Point of the Offset with the multi-selector.

- Setting range: H100%~B100%
- Default: 0%

- 6) Setting Beep [BEEP]
Set Alarm (Beep) that goes off when the Offset is activated.

- Setting range: ON/OFF
- Default: OFF

* When the Offset feature is working, X illumination and Function LED flash.

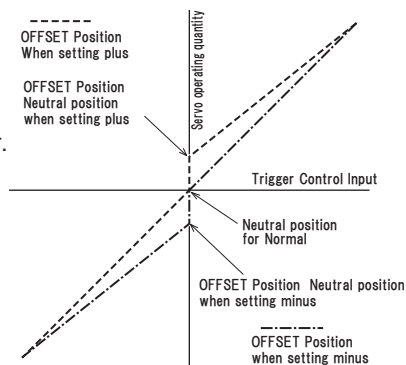

ENTER ↓ ↑ BACK

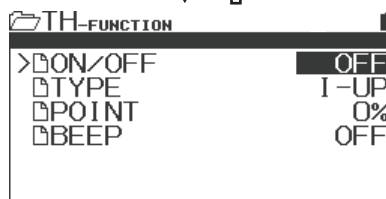

THROTTLE TYPE [TH TYPE]

THROTTLE FUNCTION/TH-FUNCTION

- You can move the neutrals position of the throttle and set the operating ratio of the forward side and the brake (backward) side to either 7:3 or 5:5.
- *Set the throttle type according to the speed controller to be used.

- 1) Select the throttle function with the multi-selector and determine with the Enter operation.
- 2) Select [TH TYPE] with the multi-selector and determine with Enter.
- 3) Setting the Throttle Type
Set the Throttle Type with the multi-selector.

- Setting range: F7:B3 / F5:B5
- Default: F7:B3

*When changing TH TYPE, the screen changes to the confirmation screen and a message is displayed. Operate following the message.



ENTER ↓ ↑ BACK

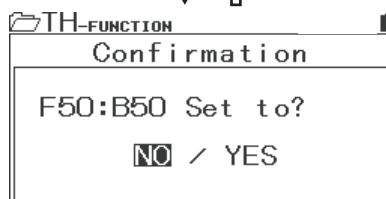

Usage of each feature

Usage of each feature

AUX

- AUX is a feature to set the performance of AUX1 and AUX2 (3ch/4ch). You can choose from STEP AUX (STEP), POINT AUX (POINT), 4WS (4-Wheel Steering: Coordinate Phase, Opposite Phase). MOA (Motor On Axle), AUX-MIX (AUX Mixing: ST à AUX/TH-AUX) and CODE5/CODE10 (Code Communication).

*Setting of AUX TYPE is done in the System Menu. Make a setting according to the purpose of the use.

STEP AUX

AUX

- Setting Step AUX allows you to set the operating quantity by operating assigned Trim or a switch.
- By factory default, the AUX feature is set to the Step AUX.

- 1) Select [AUX] with the multi-selector and define with the Enter operation.
- 2) Setting Step AUX (STEP AUX)
Determine [CH] to activate with the Select button and set the position of the motion with the multi-selector.

*Operating quantity can be set with EPA (End Point Adjustment, P.27, 28).

*Assign the features to Trim and Dial with Key Assignments according to the used method.

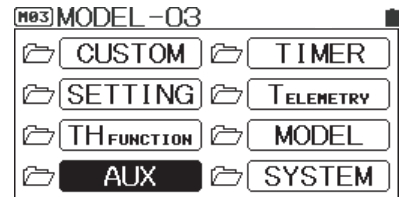

ENTER ↓ ↑ BACK

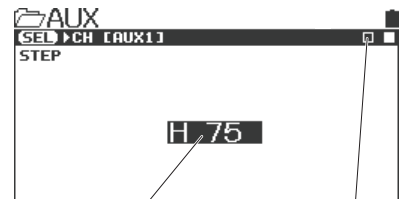

Motion Position Display

Securing a Channel with the Select Button

POINT AUX

AUX

- By setting Point AUX and assigning the movement of AUX1/AUX2 (3ch, 4ch) to the switch and Trim, you can move the servo to the set Point.
The Point that moved can be set with EPA (End Point Adjustment).
Adjust the Point position according to the usage.

* Amount of Points will be 2 ~ 6 points and can be set with AUX TYPE.

- 1) Select [AUX] with the multi-selector and set with AUX TYPE.
- 2) Setting Point AUX (POINT AUX)
Determine [CH] to activate with the Select button and set the Point of the motion with the multi-selector.

*Set to [POINT AUX] with (AUX TYPE) of (SYSTEM) according to the usage.

*Assign the features to Dial and Trim with Key Assignments to operate or operate with the multi-selector.

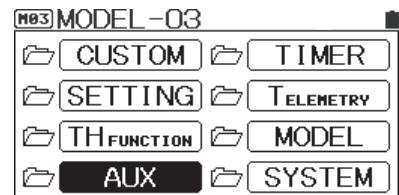

ENTER ↓ ↑ BACK

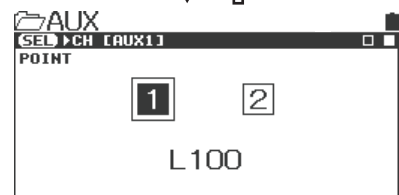

4-Wheel Steering

AUX

•With the operation of assigned Trim or Switch, control the motion of the 4 Wheel Steering.

1) Select [AUX] with the multi-selector and define with the Enter operation.

2) Setting Operating Mode

Set the Operating Mode of 4WS with the multi-selector.
Set the Operating Mode according to the usage.

* When using during operation, assign the feature of the Operating Mode to Trim or the switch.

Steering the Motion Image

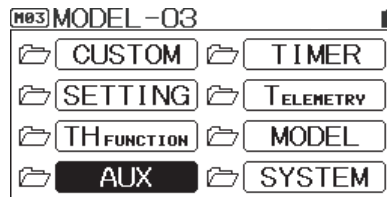
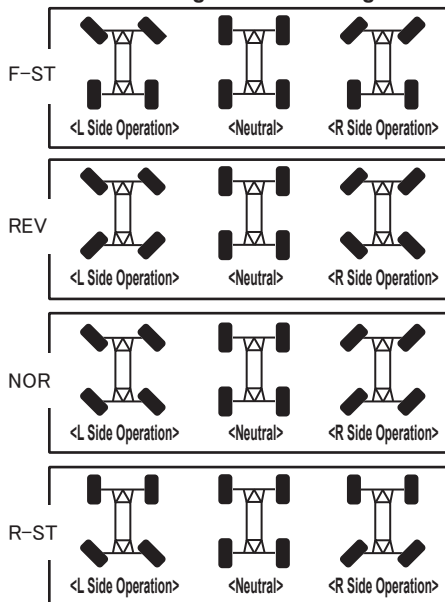

ENTER ↓ ↑ BACK

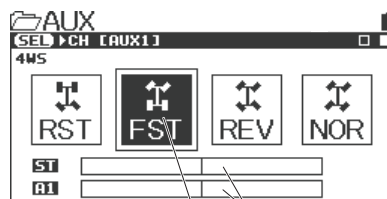

Servo Motor
Switching the Operation Mode

Usage of each feature

Motor On Axle [MOA] (Front-Rear Wheel Separate Drive)

AUX

•By setting Motor On Axle (MOA), you can adjust the drive ratio of front and rear wheels of a front-rear dual motor car.

1) Select [AUX] with the multi-selector and define with the Enter operation.

2) Setting Operating Mode

Set the Operating Mode of MOA with the multi-selector.

*Adjust Step setting to change the drive distribution of front- rear with [MODE] of [AUX TYPE] of [SYSTEM].

*When using, assign the features to Dial or Trim or operate with the multi-selector.

*Connect the speed controller for controlling the rear motor to the channel (AUX1/AUX2) that is set to MOA.

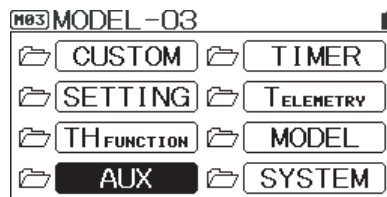

ENTER ↓ ↑ BACK

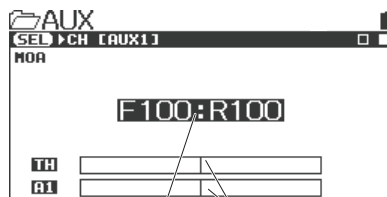

Servo Motor
Front-rear drive ratio

MOA Motion Image

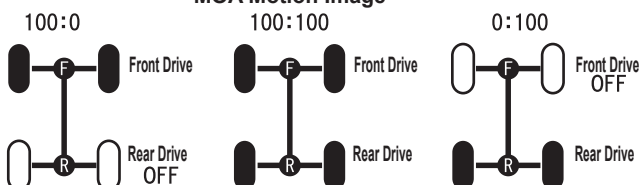

※ By changing the ratio, you can adjust the gear ratio of front-rear.

Usage of each feature

AUX

- AUX is a feature to set the performance of AUX1 and AUX2 (3ch4ch). You can choose from STEP AUX (STEP), POINT AUX (POINT), 4WS (4-Wheel Steering: Coordinate Phase, Opposite Phase), MOA (Motor On Axle), AUX-MIX (AUX Mixing: ST-AUX/TH-AUX) and CODE5/CODE10 (Code Communication).

*Setting of AUX TYPE is done in the System Menu. Make a setting according to the purpose of the use.

AUX MIXING [AUX-MIX]

AUX

- Setting AUX Mixing allows you to mix from the steering to AUX and from the throttle to AUX.

*Set AUX TYPE and MODE for operation to use for [AUX TYPE] of [SYSTEM].

- At factory, the AUX feature is set to Step AUX.

1) Select [AUX] with the multi-selector and define with the Enter operation.

2) Setting Mixing Rate
Set the Mixing Rate with the multi-selector.

◦Setting range: 0~100%

◦Default: 100%

* Set to [AUX MIX] with [AUX TYPE] of [SYSTEM] and set the Mixing performance with [MODE] according to the usage.

* Assign the features of the Mixing Rate to Trim or the switch with Key Assignments, or operate with the multi-selector.

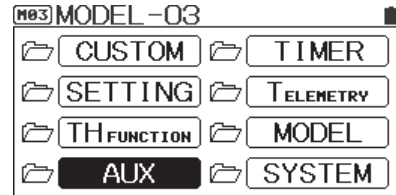

ENTER ↓ ↑ BACK

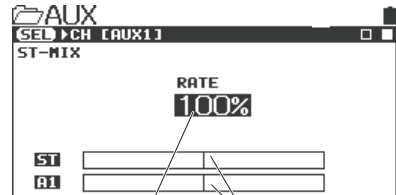

Setting Mixing Rate

Servo Monitor

CODE AUX

AUX

- Code AUX (CODE AUX) is a feature to perform code communication by assigning a setting value to each code of CODE5 and CODE10 (CODE5/5 code, CODE10/10 code). It is an extension feature to change the setting of speed controller (SUPER VORTEX series and SV-PLUS series) and the Gyro System (SGS-01C/SGS-01D) that are compatible to CODE AUX.
- You can set 2 types of Code AUX1 and CODE AUX2.
- *Setting of CODE is done by setting [TYPE] of [SYSTEM] menu. By setting [MODE], the display is changed according to each equipment. When setting [MODE] to [USER], each code display allows the user to set.
- *When using an AUX channel as CODE AUX, make sure to set the response mode of A1/A2 that are set for BIND to [SHR] (See P.49, 50).
- *When using CODE AUX, do not connect the servo to CH3 and CH4 of the receiver to be used.
- *When using, assign the features to Dial or Trim with the Key assignments or operate with the multi-selector.

- 1) Select [AUX] with the multi-selector and define with the Enter operation.
- 2) Setting Code AUX
Select [CODE AUX] to change setting and adjust the setting value with the multi-selector.

- Setting range: -100~100%
- Default: 0%

*When AUX TYPE is set to CODE5/CODE10, the following is displayed according to the setting of CODE AUX in the servo monitor display of the top screen.

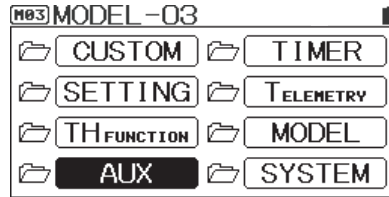

ENTER ↓ ↑ BACK

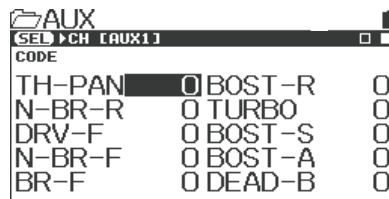

When TYPE setting is [CODE10] and MODE setting is [SV-STK]

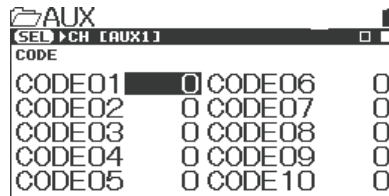

When MODE setting is [USER]

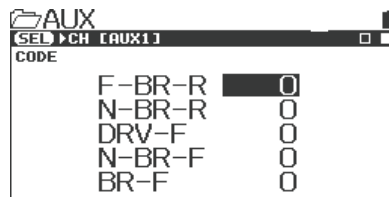

When TYPE setting is [CODE5] and MODE setting is [SVZ]

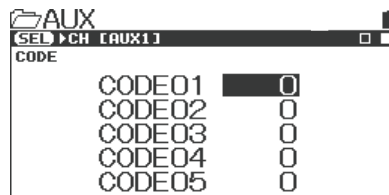

When MODE setting is [USER]

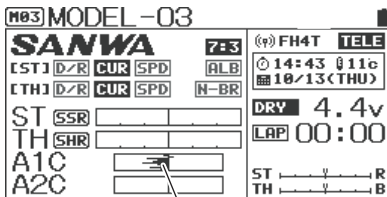

AUX TYPE = When setting is CODE AUX, bar display

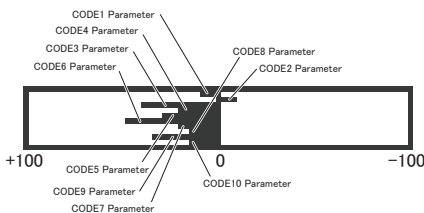

Usage of each feature

TIMER

- It has three timer features including Lap Timer, Interval Timer and Down Timer.
- When selecting a timer and operate the Select button, you can toggle between the timer screen and the setting screen.
- * When a timer is activated, X Illumination and Function LED flash.

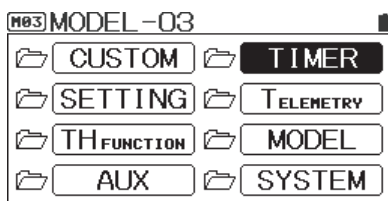

ENTER ↓ ↑ BACK

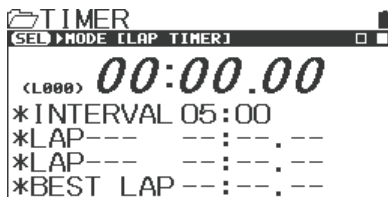

<LAP TIMER Screen>

↔
Select Button

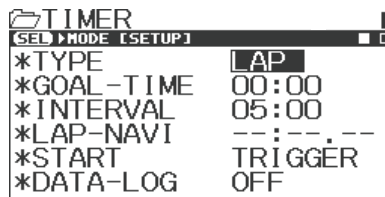

<SETUP Screen>

- You can check the lap time measured on the LAP TIMER screen.
- When Enter is being operated while Lap Timer is activated/not activated, the screen is changed to the Lap Time display. You can check each lap time with the multi-selector.

SETUP

TIMER

- Make all settings of the timers with the Setup Menu.

1) Setting TYPE

Select [TYPE] with the multi-selector to do setting.

◦Setting range: LAP/INT/DOWN

◦Default: LAP

- LAP: Possible to measure and record each lap up to 999 laps (for all models)
- INT: The timer is activated at the set time.
- DOWN: It can be a guideline for calculating running time and the fuel cost of a GP car.

2) Setting GOAL TIME

By setting a goal time, the Alarm is activated.

◦Setting range: 00:00 ~ 99:59 (00:01 unit)

◦Default: 5:00

3) Setting INTERVAL

The Alarm is activated at the set time (It tells you the lap time).

◦Setting range: 00:00 ~ 99:59 (00:01 unit)

◦Default: 01:00

4) Setting LAP NAVI

It activates the alarm at the set time at the time of running and uses it as a guideline for the goal time.

◦Setting range: 00:00, 01s~99:59, 99

◦Default: --:--:--

*LAP NAVI will not start at 00:00.00.

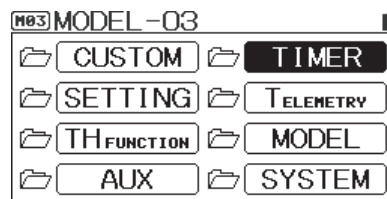

ENTER ↓ ↑ BACK

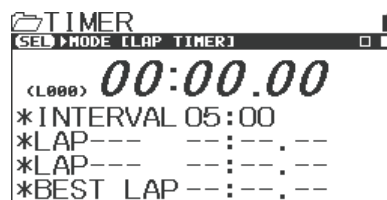

Select Button ↓

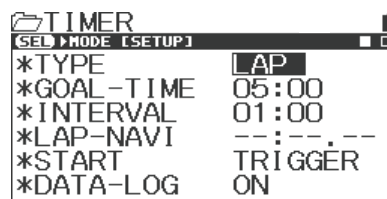

5) Setting START

Set the Timer Start from the Trigger Interlock/Switch/Random.

- oSetting range: TRIGGER/SW/RANDOM
- oDefault: TRIGGER

6) Setting DATA-LOG

It sets Telemetry Data Log (record) along with the timer.

- oSetting range: OFF/ON
- oDefault: OFF

*Log starts along with the timer feature.

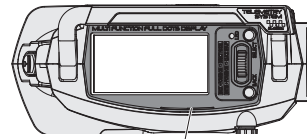

Function LED

X Illumination

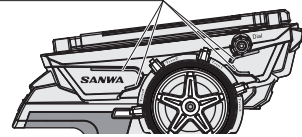

LED flashes while the timer is activated.

LAP TIMER

TIMER

- You can measure and record each lap up to 999 laps (works for all models).
- Pre Alarm (PRE-ALM) is installed and the alarm goes off before the goal.

1) Select [TIMER] with the multi-selector and determine with the Enter operation.

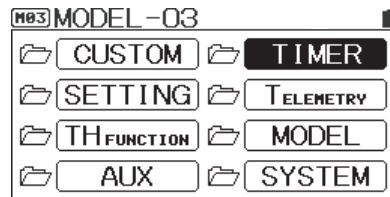

2) Starting the Timer

As a default, the timer switch is set to SW1. By holding SW1, the timer becomes a standby state for starting and by either pressing SW1 again or operating the throttle trigger, measuring starts.

3) Every time you operate SW1, lap time is measured.

The switch does not work for 3 seconds after operating SW1.

4) Completing measuring

By holding SW1, measuring will be completed.

*You can check the measured lap time on the LAP TIMER screen.

When Enter is being operated while the lap timer is activated/ stopped on the LAP TIMER screen, the screen is changed to the lap time display. You can check each lap time with the multi-selector operation (not possible on the SETUP screen).

*When turning the power switch off while the timer is activated, the timer will be reset.

*When the timer is set to SW1/SW2, the timer will be in the standby mode by holding the switch even on a screen other than the setting screen.

ENTER ↓ ↑ BACK

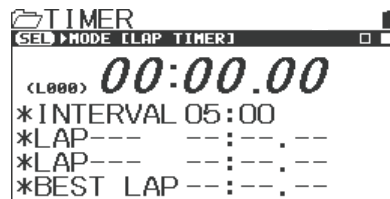

ENTER ↓ ↑ BACK

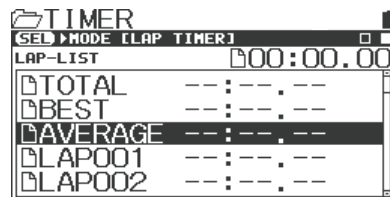

SWITCH1

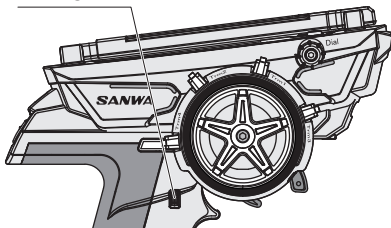

Usage of each feature

Interval Timer [INT TIMER]

TIMER

● It activates the alarm at the time set at the beginning of running and uses it as the guideline for the goal time.

- 1) Select [TIMER] with the multi-selector and determine with the Enter operation.
- 2) Setting the Type [TYPE]
Operate the Select button and select [INT] with [TYPE].

- 3) Setting Interval (INTERVAL)
Set the Interval Timer with [INTERVAL].

- 4) Starting Interval Timer
As a default, the timer switch is set to SW1.
When holding SW1, the timer will be in the standby mode and measuring will start when you press SW1 again or operate the trigger.

- 5) Every time you operate SW1, the Interval Timer will be reset

- 6) Completing measuring
By holding SW1, measuring will be completed.

*When turning the power switch off while the timer is activated, the timer will be reset.

*When the timer is set to SW1/SW2, the timer will be in the standby mode by holding the switch even on a screen other than the setting screen.

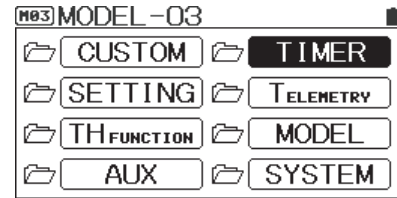

ENTER ↓ ↑ BACK

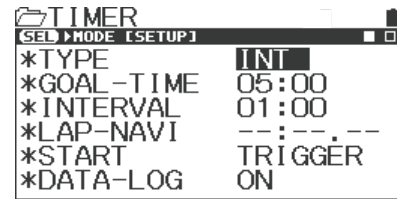

SWITCH 1

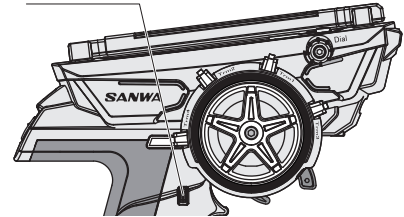

DOWN TIMER

TIMER

- It can be a guideline for calculating running time of an electric RC car and the fuel cost of an engine RC car.
- You can set for per second up to 99 : 59.
- When the timer switches to the Up Timer after the Down Timer ends, you can check the lap time after the end.

- 1) Select [TIMER] with the multi-selector and determine with the Enter operation.
- 2) Setting the Type [TYPE]
Operate the Select button and select [DOWN] with [TYPE].

* Set the Down Timer with [GOAL-TIME] of SETUP.

- 3) Starting Down Timer
As a default, the timer switch is set to SW1.
When holding SW1, the timer will be in the standby mode and measuring will start when you press SW1 again or operate the throttle trigger.

- 4) Every time you operate SW1, the Down Timer will be reset.

- 5) Completing measuring
By holding SW1, measuring will be completed.

*When turning the power switch off while the timer is activated, the timer will be reset.

*When the timer is set to SW1, the timer will be in the standby mode by holding the switch even on a screen other than the setting screen.

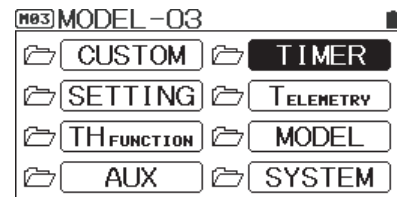

ENTER ↓ ↑ BACK

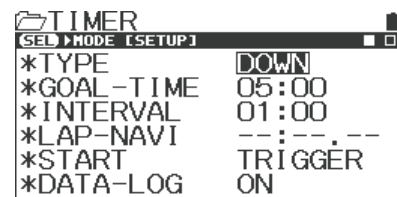

TELEMETRY

- A menu for setting Telemetry-related LOG DATA, TELEMETRY SETTING, GRAPH SETTING and TELEMETRY SWITCH.
- To use the Telemetry feature, you can make it compatible by using a compatible receiver or sensors, SUPER VORTEX series or SV-PLUS series.
- With Telemetry, you can check the data of 2 temperature systems, battery voltage and number of rotations with the transmitter.

- LOG DATA: Menu for controlling log data that is being recorded
- TELEMETRY SETTING: Various settings of Telemetry features
- GRAPH SETTING: Setting for graph display
- TELEMETRY SWITCH: Various settings of the switch to activate based on the Telemetry data.

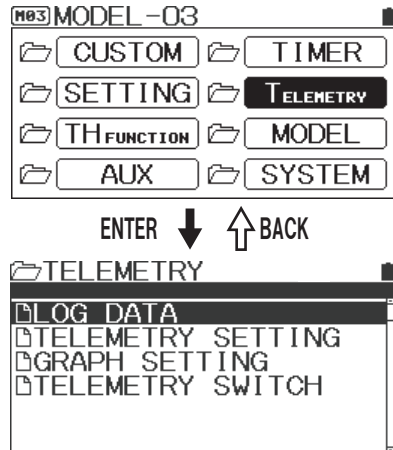

LOG DATA

TELEMETRY

- A feature to control the log data for creating a graph, saving onto an Micro SD card and deleting log data by reading the recorded log data.

- 1) Select [LOGGER] with the multi-selector and determine with the Enter operation.
- 2) Select [LOG DATA] and determine with the Enter operation.
- 3) Select the saved log data with the multi-selector.
When Enter is being operated the menu is displayed.
Select the menu and determine with the Enter operation.

- VIEW DATA: Reads the recorded log data and creates a graph.
- DATA NAME: Edits the file names of the log data.
- EXPORT [.CSV]: Converts (the data?) to CVS format and saves onto a micro SD card.
- PROJECT: Protects and saves the log data.
- DELETE: Deletes the log data.

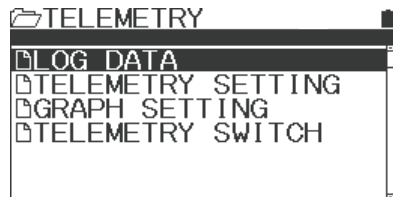

ENTER ↓ ↑ BACK

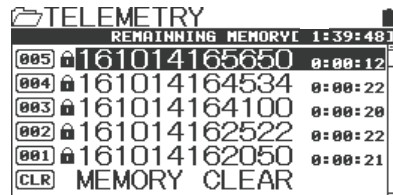

ENTER ↓ ↑ BACK

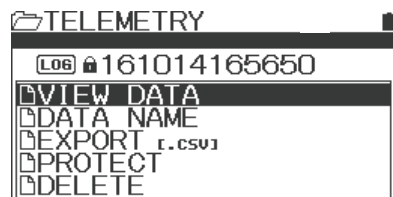

Usage of each feature

VIEW DATA

- A menu to read the recorded log data and creates a graph.
 - 1) Select [LOG DATA] with the multi-selector and determine with the Enter operation.
 - 2) Select LOG DATA to create a graph and determine with the Enter operation.
 - 3) By selecting the log data, a menu will be displayed.
By selecting [VIEW DATA], the log data is displayed as a graph.
 - 4) Setting the Display Size
When Enter is being operated while a graph is displayed, it sets the size of the graph to display.
 - Setting range: 1/1 (8.5s/PAGE): 1 page/8.5 seconds
 - 1/2 (17s/PAGE): 1 page/17 seconds
 - 1/4 (34s/PAGE): 1 page/34 seconds
 - 1/8 (68s/PAGE): 1 page/68 seconds
 - Default: 1/1(8.5s/PAGE)
- 5) Methods to move a page
When operating the Select button while a graph is displayed, you can set the method to move the displayed page.
 - Setting range: Cursor/Page/Lap
 - Default: Cursor

*When Enter is being operated on the screen, which a graph is displayed on, it moves to the lap list.

TELEMETRY

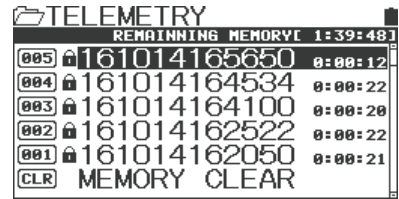

ENTER ↓ ↑ BACK

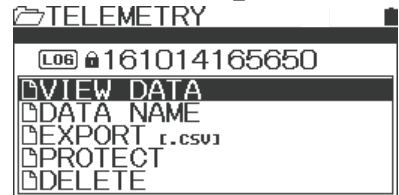

ENTER ↓ ↑ BACK

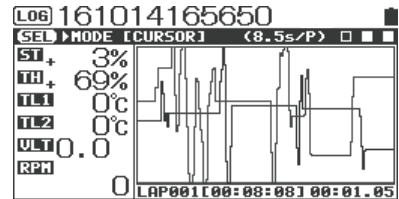

DATA NAME

- A feature to change the file names of the selected log data.
- Only alphabets and numbers can be used for file names.
 - 1) Select [LOG DATA] with the multi-selector and determine with the Enter operation.
 - 2) Select LOG DATA to change the file name and determine with the Enter operation.
 - 3) Setting the Data Name
With the multi-selector, move the cursor “_” to the position where texts are entered. Once the position is set, determine the cursor position with the Enter operation.
- *Once the cursor position is set, it moves to the selection of text input.
- 4) Determining Texts to enter
Select texts to enter with the multi-selector.
Once you have determined which texts to enter, input with the Enter operation.
 - Setting range: A~Z, a~z, 0~9, Symbols

*When changing texts that have been entered or moving the cursor of text input, press the back button and cancel the action.

*To switch between alphabets and numbers, use the Select button.

TELEMETRY

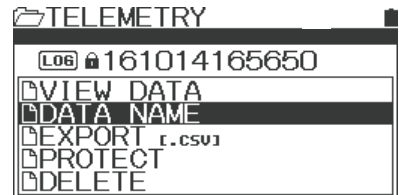

ENTER ↓ ↑ BACK

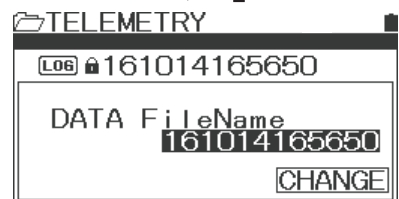

ENTER ↓ ↑ BACK

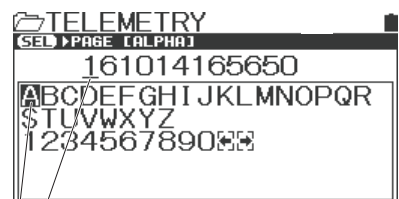

Text Position Cursor (it flashes when moving the cursor.)

Text Input Selection Cursor

EXPORT[.CSV]

TELEMETRY

- A feature to convert the selected log data to a graph with PC (Personal Computer) software such as a spreadsheet software.
- Please note that data converted by the Export feature cannot be converted to a graph with the transmitter.
- When using the Export feature, a micro SD card is necessary.

- 1) Select [LOG DATA] with the multi-selector and determine with the Enter operation.
- 2) Select LOG DATA to export and determine with the Enter operation.
*With the Enter operation, it moves to CSV file name (Changing File Name).
- 3) Setting CSV File Name
When changing the format, you can change the File Name also. Text input is the same as the data name. Refer to the data name input.
- 4) Conversion to CSV File Format
Move the cursor to [SAVE] and convert with the Enter operation.

*You can cancel the conversion operation during converting data with the back operation.

*Move the data to the PC via a micro SD card after converting the data and display a graph.

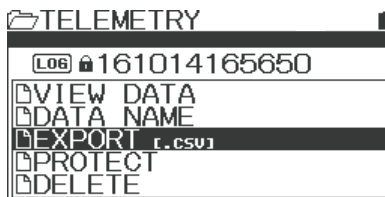

ENTER ↓ ↑ BACK

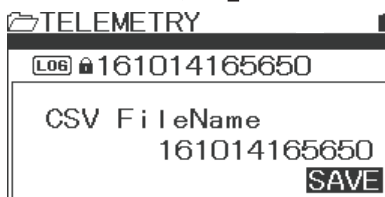

ENTER ↓

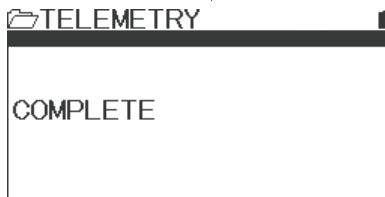

PROTECT

TELEMETRY

- A feature to protect the log data from accidental deletion.

- 1) Select [LOG DATA] with the multi-selector and determine with the Enter operation.
- 2) Select LOG DATA to protect and determine with the Enter operation.

* With every Enter operation, it toggles Effective/Non-effective of protection.

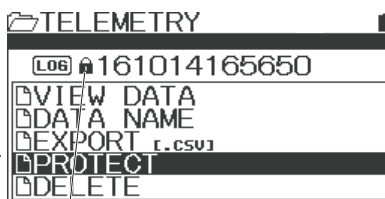

Protection Mark

DELETE

TELEMETRY

- A feature to delete the log data.
- Protected data cannot be deleted.

- 1) Select [LOG DATA] with the multi-selector and determine with the Enter operation.
- 2) Select log data to delete and determine with the Enter operation.
The confirmation screen will be displayed. Operate the following screen display.

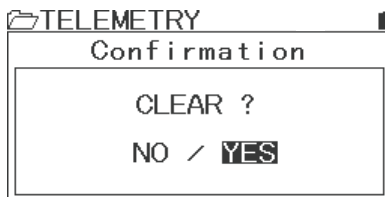
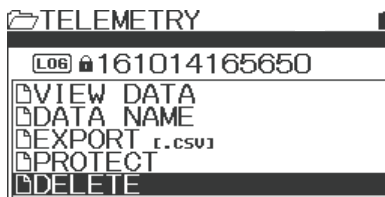

Usage of each feature

LOGGER

TELEMETRY SETTING

TELEMETRY

● Set each feature of Telemetry. Select the feature to set with the select button.

- TLM1/TLM2: Setting the Telemetry Data of Temperature/Speed
 [NAME] Up to 3 characters of data names of TLM1/TLM2 are changeable.
 [UNIT] Setting the Temperature and changing the Speed display.
 (C/ F/KM [Speed unit is changeable])
 [MAX] Setting the graph's maximum value when displaying the data as a graph.
 [ALERT] Activates the alarm at the set temperature.
 (*It cannot set for displaying the speed.)
 [MIN] Setting the graph's minimum value when displaying the data as a graph.

- RPM: Setting the Speed figured from the number of rotation data
 [UNIT] Switching the number of rotation and the speed display
 (RPM, km/h, mph)
 [MAX SCALE] Setting the graph's minimum value when displaying the data as a graph.

- RATIO: When setting RATIO RPM sensor in the subtracted position, you can display the number of rotations of the motor and engine after calculating backward by setting RATIO.

○ Setting range: 00.001~64.999

○ Default: 01.000

- 10COUNT DIST: When setting to [10 Count Distance] Speed display, the RPM sensor measures the moving distance that has been detected 10 times, calculate the speed and displays it by setting the value.

○ Setting range: 1cm~255cm

○ Default: 30cm

- VOLT: Alarm is activated at the set voltage corresponding to the Telemetry Data and LED flashes.

[MAX VOLT] Setting the maximum temperature

○ Setting range: 3.0V~9.0V

○ Default: 9.0V

[ALERT VOLT] Setting the Alarm Activation Voltage

○ Setting range: 3.0V~9.0V

○ Default: 3.8V

- 1) Select [LOGGER] with the multi-selector and determine with the Enter operation.
- 2) Select [TELEMETRY SETTING] with the multi-selector and determine with the Enter operation.
- 3) Select the features to set with the Select button and adjust various settings with the multi-selector.

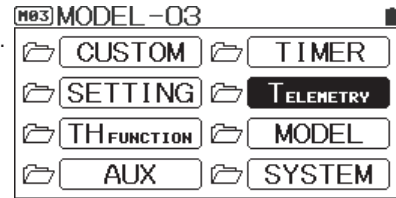

ENTER ↓ ↑ BACK

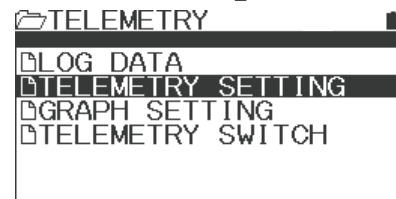

ENTER ↓ ↑ BACK

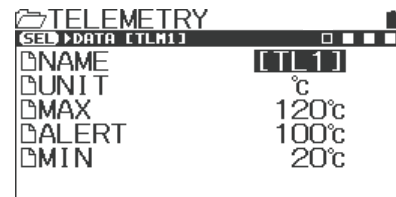

SELECT BUTTON ↓↓

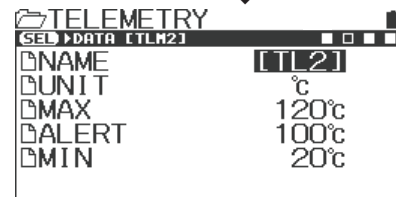

SELECT BUTTON ↓↓

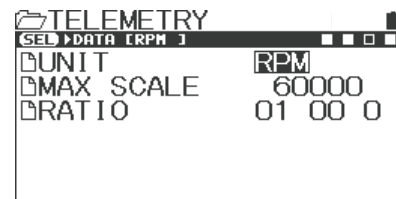

SELECT BUTTON ↓↓

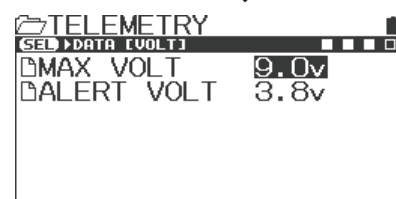

GRAPH SETTING

TELEMETRY

●A feature to select 3 items to be displayed in a graph when displaying Telemetry data as a graph.

1) Select [TELEMETRY] with the multi-selector and determine with the Enter operation.

2) Setting GRAPH SETTING

Select [GRAPH SETTING] with the multi-selector and determine with the Enter operation.

○Setting range: TL1/TL2/RPM/VOLT/ST/TH

TLM1/2: Telemetry Data

RPM:RMP: Rotation Number Data

VOLT: Receiver Input Voltage

○Default: LINE1: ST (Steering Data)

LINE2: TH (Throttle Data)

LINE3: VOLT (Receiver Input Voltage)

*In a graph, LINE1 is displayed in black, LINE2 in dark grey and LINE3 in light grey.

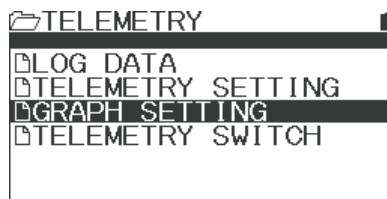

ENTER ↓ ↑ BACK

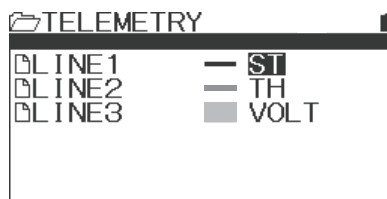

TELEMETRY SWITCH

TELEMETRY

●A feature that allows you to activate the switch with the Telemetry data based on the change of the same data.

• TRIGGER: Selects the data that will be the source of the switch operation.

• BORDER: A setting for operation standards of temperature or voltage.

• FUNCTION: Assigns functions.

1) Select [TELEMETRY] with the multi-selector and determine with the Enter operation.

2) Setting TELEMETRY SWITCH

Select [TELEMETRY SWITCH] with the multi-selector and determine with the Enter operation.

○Setting range: TRIGGER: OFF/TL1/TL2/VOLT

BORDER: When setting temperature, 0 ~ 150C°
When setting voltage, 3.0 ~ 9.0V

FUNCTION: TIMER ON/OFF

RACING MODE

TH RATE

MODE: TOGGLE/ONE SHOT

○Default: TRIGGER: OFF

BORDER: ----(OFF)

FUNCTION: ----(OFF)

MODE: ----(OFF)

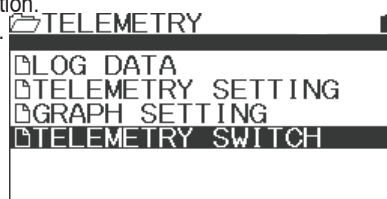

ENTER ↓ ↑ BACK

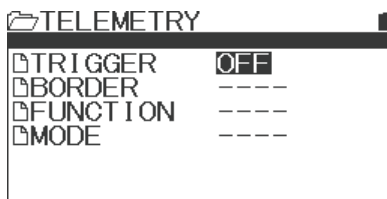

Usage of each feature

Model Menu

MODEL

- You can set the features about Model Select, Model Name, Model Copy and Model Clear.
- Installed with high capacity EEPROM and it can memorize data for 20 models of M01 ~ M20.

MODEL SELECT

- You can call model data of memorized M01 ~ M20 easily.

- 1) Select [MODEL] with the multi-selector and determine with the Enter operation.
- 2) Setting Model Select (MODEL SELECT)
Select [MODEL SELECT] with the multi-selector and determine with the Enter operation.
- 3) Selecting Model
Select Model to call with the multi-selector.

◦ Setting range: M01~M20

- 4) When moving the cursor to the model to call and Enter is being operated, a message is displayed on the screen. Follow the display to operate and select a model.

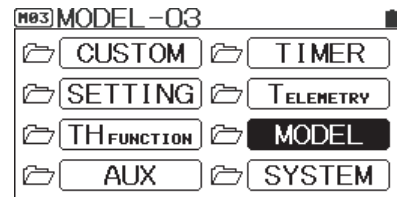

ENTER ↓ ↑ BACK

Current Model Display

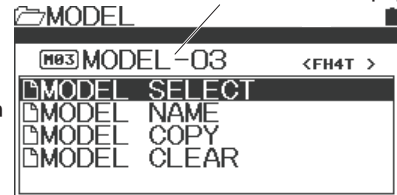

ENTER ↓ ↑ BACK

RF MODE

② MODEL SELECT Screen

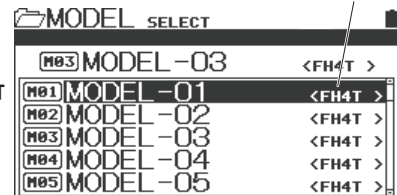

ENTER ↓ ↓ BACK

Completing Model Selection ① To the Model Screen

Supplement

- MT-44 has a feature of Direct Model Select. When turning the power switch of the transmitter on while pressing the Back button, it starts from the MODEL SELECT screen so that you can easily call a model to use. (P. 16)

MODEL NAME

- You can register a model name with up to 12 characters of alphabets, numbers, EU Font and symbols for each model.

- Select [MODEL] with the multi-selector and determine with the Enter operation.
- Setting Model Name [MODEL NAME]
Select [MODEL NAME] with the multi-selector and determine with the Enter operation.
- Setting Model Name
Move the cursor "_____ " with the multi-selector to the position to input texts. Once the position is determined, press the Enter key to determine the cursor position.
- Select texts to enter with the multi-selector.
Once the texts to enter are determined, enter with the Enter key. Switching of alphabets/lower case/symbols/EU Font is done by operating the select button.

*When changing texts are already entered or when moving the cursor of the text input position, press the Back button to cancel the action.

○Setting range: A~Z, a~z, 0~9, Symbols, Space

- Repeat 3) and 4), and enter texts.

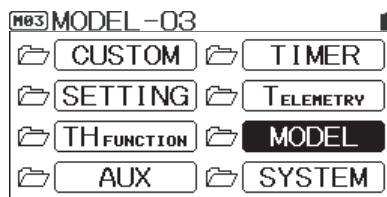

ENTER ↓ ↑ BACK

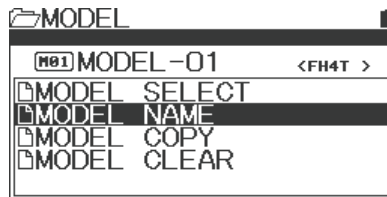

ENTER ↓ ↑ BACK

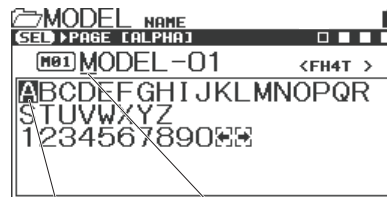

Text Input Selection Cursor

Text Position Cursor (It flashes when moving the cursor)

Alphabet lower cases

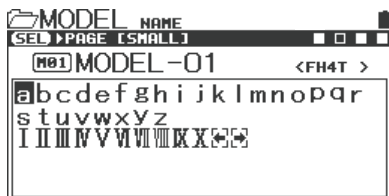

Symbols

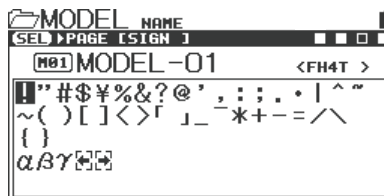

Usage of each feature

Model Menu

MODEL

- You can set the features about Model Select, Model Name, Model Copy and Model Clear.
- Installed with high capacity EEPROM and it can memorize data for 20 models of M01 ~ M20.

[MODEL COPY]

- You can copy a selected model data to another model.

1) Select [MODEL] with the multi-selector and determine with the Enter operation.

2) Setting Model Copy [MODEL COPY]
Select [MODEL COPY] with the multi-selector and determine with the Enter operation.

3) Selection of a Copy Destination Model
Select a Copy Destination Model with the multi-selector.

*You can also select the copy source Model.

*For the copy source Model and the Copy destination Model, you can also select a micro SD card. When selecting a micro SD card as a copy source, and when there is no model data, you cannot copy.

4) When Enter is being operated a message is displayed on the screen. Follow the display to operate and complete Model Copy.

• About the Mode of Model Copy

- FULL
All settings in the Model Data will be copied.
- SYSTEM
Select the contents of SYSTEM of Model Data.
- MODEL
Setting within Model Data, TH Function
Copying only the setting value of AUX

Select a mode of Model Copy for your usage.

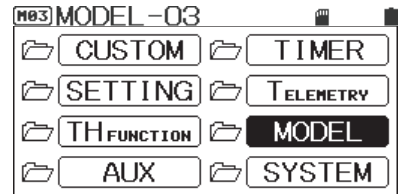

ENTER ↓ ↑ BACK

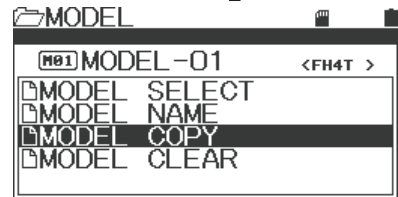

ENTER ↓ ↑ BACK

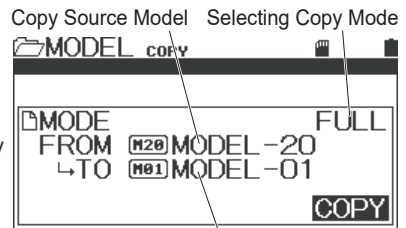

① Selecting Copy Destination

Copy Destination Model

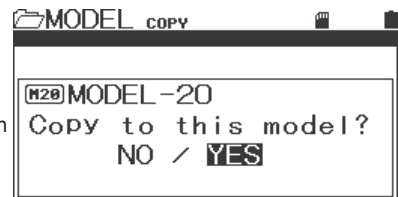

② Copy Confirmation Screen

ENTER ↓
• NO → Back to 1
• YES → Move to 3 (Copy)

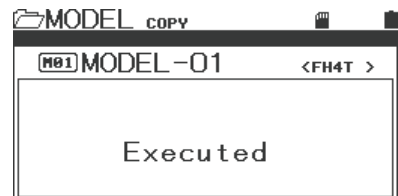

③ Copying

Back to 1 after copying

- About copying from a micro SD card
When performing Model Copy, the main body memory and a micro SD card can select designation of the copy source and the copy destination. When selecting a Model on the copy destination selection screen, you can select with the Select button operation.

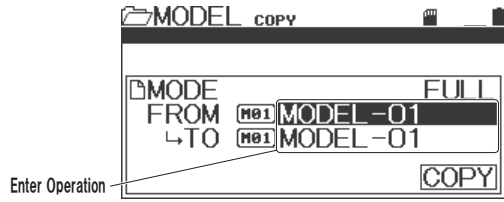

1)When a model is selected, designation of the copy source and the copy destination other than the main body memory can also be selected. It is switched by the operation of the select button.

- MEMORY (Main Body Memory): 20 memory
- SD CARD (Micro SD Card): 250 memory
- SD EXP. (Micro SD EXP.): 20 memory

*SD EXP. copies data like the template data.
Download the template data from our HP to use.

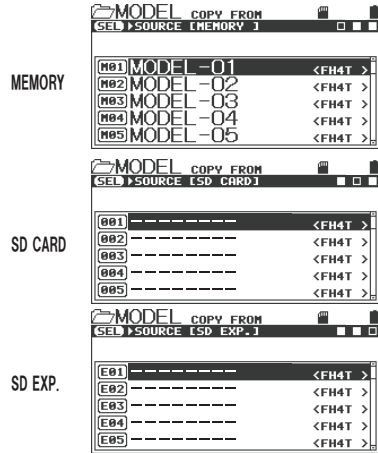

[MODEL CLEAR]

●A feature to clear (initialize) the setting data of Models.

- 1)Select [MODEL] with the multi-selector and determine with the Enter operation.
- 2)Setting Model Clear [MODEL CLEAR]
Select [MODEL CLEAR] with the multi-selector and determine with the Enter operation.
- 3)Select Model Data to perform Model Clear.
You can also select the main body memory and Model Data in the micro SD card by operating the Select button.
- 4)When Enter is being operated, a message is displayed on the screen. Follow the display to operate and complete Model Clear.

●About the Model Clear Mode

- FULL
All settings in the Model Data will be cleared.
- SYSTEM
Select in the contents of SYSTEM of Model Data and clearing
- MODEL
Setting within Model Data, TH Function
Clearing only the setting value of AUX

① Confirmation Screen

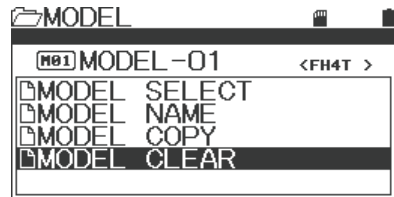

ENTER ↓ ↑ BACK

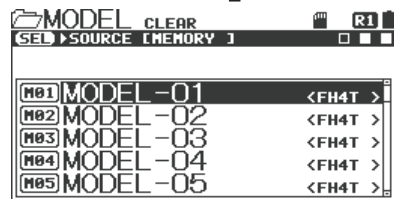

ENTER ↓ ↑ BACK

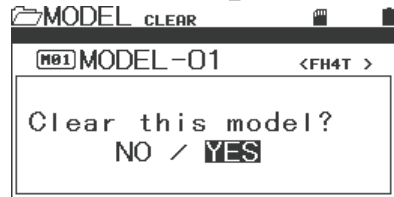

•NO →Return to MODEL screen
•YES→Start Clearing Go to 2

② Clearing in progress

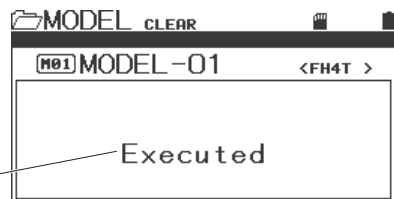

After Rotation Reduction is displayed Return to <MODEL> screen

Select for your usage.

Usage of each feature

System Menu

SYSTEM

- A feature for setting system of the transmitter, such as Bind (BIND), Key Assignments (KEY ASSIGN), BUZZER (Buzzer), Battery (BATTERY), LCD and CALIBRATION (Calibration).

[BIND]

- Select the output system that suits the receiver, set a mode for the servo (analog/digital) and the speed controller to be used and bind the transmitter with the receiver.

1) Select [SYSTEM] with the multi-selector and determine with the Enter operation.

2) Select [BIND] with the multi-selector and determine with the Enter operation.

3) Setting RF MODE (RE MODE: Signal output system)
Set the output system with the multi-selector.

- Output System
 - FH4T
RX-482, RX-481, RX-472, RX-471, RX-47T
RX-462, RX-461, Mode for SV-PLUS series
 - FH3
RX-451R, RX-451, RX-381, Mode for RX-380

○ Output System

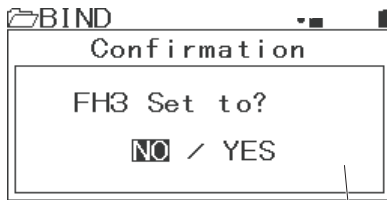

Confirmation Screen

*When changing the output system, a message is displayed on the screen. Follow the display to operate.

4) Setting TELEMETRY

Set TELEMETRY with the multi-selector.

Setting range: ON/OFF

- Default : ON

*Telemetry Compatible Equipment

- RX-482, RX-472, RX-47T, RX-462, RX-461, SV-PLUS series

*Re-BIND is not necessary even if setting is changed.

5) Setting SAFETY LINK

Set SAFETY LINK (Safety Link) with the multi-selector.

- Setting range: 01 ~ 50

- Default : 01

*When changing the setting of SAFETY LINK after BINDING, BIND again.

Output System

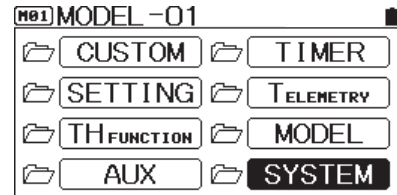

ENTER ↓ ↑ BACK

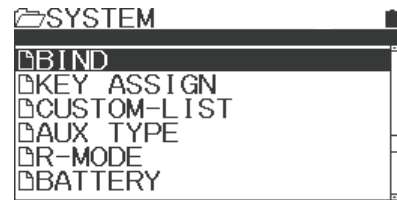

ENTER ↓ ↑ BACK

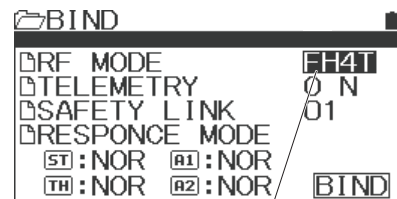

Output System

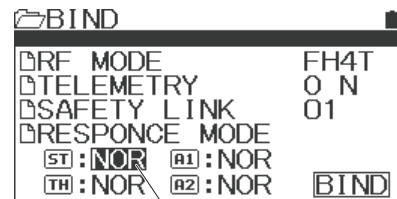

Response Mode

Supplement

- A feature for preventing runaway due to an error of Model Select. You can set a Link No. for each Model
- When performing Model Copy (FULL), the Link No. is also copied.
- Default is set to [01]. When Link No. is not being changed, receivers that are BINDED will be working for all models
- Safety Link works only for [FH4T].

5) Setting Channel Mode

Set the response mode for each channel with Up key/Down key.

- You can set the response mode for each channel.

- Setting range: NOR (Normal)
SHR (High Response)
SSR (Super Response)

- Default : NOR

*The response mode of SSR is displayed only when FH4T is set.

Important

- Note that, in SHR/SSR mode, an analog servo will not work. If you mistakenly use an analog servo in SHR/SSR mode, it will not operate normally and the servo will be broken. Do not use an analog servo in SHR/SSR mode. For digital servo (SRG, ERB ERS series, Digital ERG series), it can work for either mode of NOR/SHR.
- SSR mode works only for SRG servo, SUPER VORTEX/SV-PLUS series, HV-12 STOCK SPECIAL and HV-01.
- SSR mode cannot be used in MT-44 even if RX-451R is used to BIND on the SHR display. It will act as it is shown in the display.
- In SHR/SSR mode, BL/RACER, BL/FORCE, F2000, F2200, F3000, F3300, SBL-01, 02 and 03CL do not work.
- SV-08, HV-10, HV-12 and F2500 work in NOR/SHR mode.

6) Setting BIND (Bind)

- What is BIND: Each of MT-S transmitters has its own unique ID (solid identification) number. BIND is to let the receiver memorize the ID number. Operation will be possible only between the transmitter and the receiver that completed Binding.

- When setting in the BIND menu is done, set BIND with the multi-selector.

- Move the cursor to [ENTER] in the BIND menu and operate Enter. The transmitter now is ready for BIND operation.

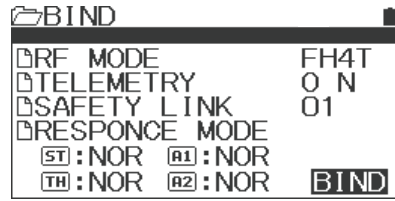
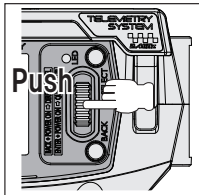

ENTER ↓

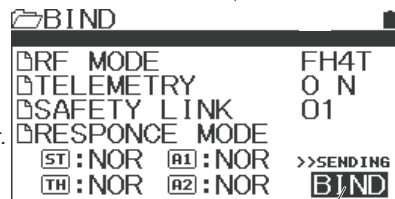

Flashing

- Turn the power switch on while holding the BIND button of the receiver.

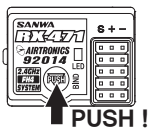

Holding BIND button of receiver,

Turn Power Switch ON !



Turn on the power switch of receiver/FET ESC.

NOTE)The above picture don't have wiring. However, before binding, please connect servo, FET ESC (without motor), battery.

- When BINDING is done properly, the LED of the receiver starts flashing slowly at first then it flashes in high speed and the LED goes off. When the LED of the receiver goes off, operate the Enter key of the transmitter to complete BINDING of the transmitter. When BINDING is done properly, the LED of the receiver is lit. When the LED of the receiver is lit, activate the servo to check if BINDING is completed.

*When BINDING cannot be done properly, restart from step 2).

Status of the Receiver LED

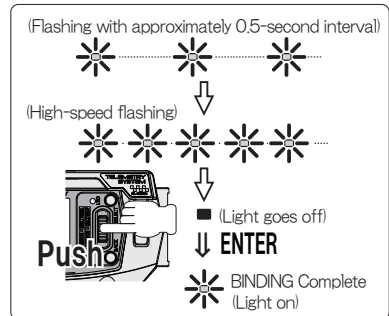

Note

- BINDING is not done at the factory. Please make sure to complete BINDING before use.
- When the receiver is new, make sure to complete BINDING for the transmitter and the new receiver.
- Make sure to use the set of the transmitter and the receiver that completed BINDING.
- When BINDING RX-451, R-451R, RX-381 and RX-380, set RF-MODE (output system) to FH3 to BIND.
- If you use a receiver of a wrong type or make a wrong setting of MODURATION, you cannot perform BINDING.
- When changing the setting in the BIND menu after BINDING, repeat BINDING.
- RX 481 and RX-471 work for either FH4T or FH3, but use with FH4T to have the receiver's original performance.
- When changing the setting of the mode (NOR/SHR/SSR) after BINDING, repeat BINDING. If you do not re-BIND, setting changes will not be reflected.

Usage of each feature

SYSTEM MENU

SYSTEM

- A feature for setting system of the transmitter, such as BIND, KEY ASSIGN, BUZZER, BATTERY, LCD and VR ADJUST (Volume adjustment).

Positions of the Switch and Trim

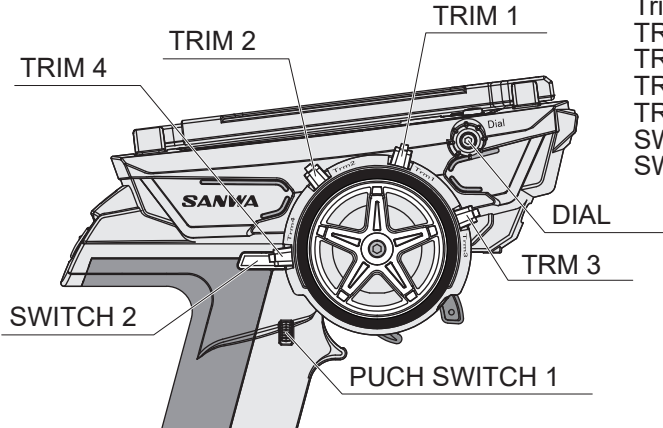

Features assigned to the Switch and Trim at the factory

- TR1 : Steering Trim(TRM-ST)
- TR2 : Throttle Trim(TRM-TH)
- TR3 : Dual Rate ST(D/R-ST)
- TR4 : Dual Rate BR(D/R-BR)
- SW1 : Timer (TIMER)
- SW2 : CUSTOM

KEY ASSIGN SWITCH [KEY ASSIGN SW]

- You can assign features to the switches (SW1, SW2, SW3) of the transmitter and toggle ON/OFF of the features during operation.

1) Select [SYSTEM] with the multi-selector and determine with the Enter operation.

2) Select [KEY ASSIGN] with the multi-selector and determine with the Enter operation.

3) Setting the Switch (SW1/SW2)
Operate the Enter with [SW] and set the feature to assign to the switch with Up key/Down key.

◦ Setting range:

SWITCH	An assignable feature
SW1	OFF, ASIST-ST, D/R-ST, D/R-TH, D/R-BR, CUR-ST, CUR-TH, SPD-ST, SPD-TH, ALB, OFFSET, AUX1, AUX2, TIMER, TE-CLR, LOGGER, R-MODE
SW2	

- Default : SW1: TIMER SW2: OFF
- *BY Setting [ASSIST-ST] onto SW1/SW2, you can turn ON/OFF the feature of D/R, SPEED and CURVE that can be set onto the steering.

4) Setting Mode
It sets the switch performance but there are cases that you cannot set depending on the feature to assign.

- Setting range:
TOGGLE (Switching between ON/OFF when pressed every time)
PUSH (ON only during being pressed)

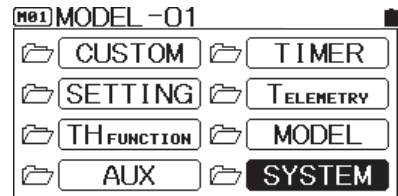

ENTER ↓ ↑ BACK

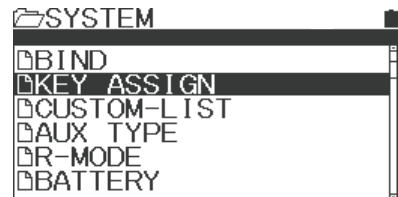

ENTER ↓ ↑ BACK

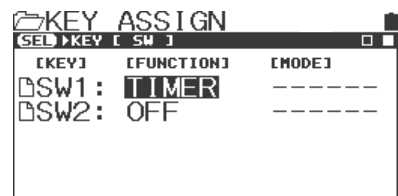

KEY ASSIGN TRIM

- You can change the setting value of each feature with Trim1 - Trim4.
- You can also change the setting of the variation change in one time of Trim operation with the STEP setting and the direction of the action with the REV setting.

- 1) Select [SYSTEM] with the multi-selector and determine with the Enter operation.
- 2) Select [KEY ASSIGN] with the multi-selector, switch to [TRIM] with the Select button, select an item to set and determine with the Enter operation.
- 3) Setting Trim (TRM1/TRM2/TRM3/TRM4)
Select [TRIM] to change the setting and set a feature to assign with the multi-selector.

KEY ASSIGN			
[KEY]	[FUNCTION]	[STEP]	[REV]
TR1	: TRM-ST	5	NOR
TR2	: TRM-TH	5	NOR
TR3	: D/R-ST	1	NOR
TR4	: D/R-BR	1	NOR
DIAL	: OFF	---	---

○Setting range:

TRIM	An assignable feature
TRIM1	OFF, TRIM-ST, TRM-TH, TRIM-A1, TRIM-A2, D/R-ST,
TRIM2	D/R-TH, D/R-BR, CU-R-ST, CU-R-TH, CU-R-BR,
TRIM3	SP-ST-F, SP-ST-R, SP-TH-F, SP-TH-R, ALB-PO,
TRIM4	ALB-ST, ALB-LG, ALB-CY, OFFSET, AUX1, AUX1(CODE1~10), AUX2, AUX2(CODE1~10)

- Default TR1 : TRM-ST
- TR2 : TRM-TH
- TR3 : D/R-ST
- TR4 : D/R-BR

4) Setting Step (STEP)

Set the variation of the movement by one-time Trim operation.
Select [STEP] with the multi-selector, determine with the Enter operation and set the variation.

- Setting Range: 1~100
- Default: 5

5) Setting the Direction of Action

Set the direction of action when operating Trim.
Select [REV] with the multi-selector, determine with the Enter operation and set the direction of action.

- Setting Range: NOR/REV
- Default: NOR
- Default: TRIM-1 : Steering Trim(TRM-ST)
- TRIM-2 : Throttle Trim(TRM-TH)
- TRIM-3 : Steering Dual Rate(D/R-ST)
- TRIM-4 : Brake Dual Rate(D/R-BR)

USAGE OF EACH FEATURE

SYSTEM MENU

SYSTEM

CUSTOM LIST

- By setting an often-used menu onto the custom list, you can build your favorite menu.
You can create a custom list for each model memory and you can create a 4-page list.
- A menu set with the custom list will be usable in custom.

- 1) Select [SYSTEM] with the multi-selector and determine with the Enter operation.
- 2) Select [CUSTOM-LIST] with the multi-selector and determine with the Enter operation.
- 3) Setting Custom List
Using the multi-selector, set the channel/feature/item..
You can assign 6 features per page and set for 4 pages.

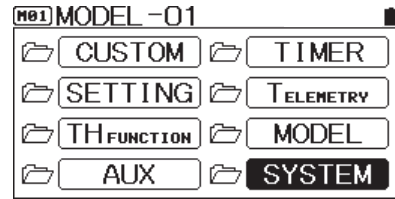

ENTER ↓ ↑ BACK

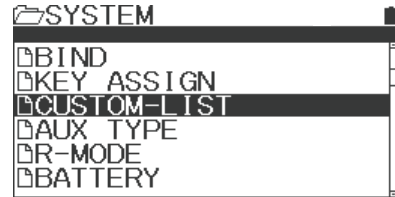

ENTER ↓ ↑ BACK

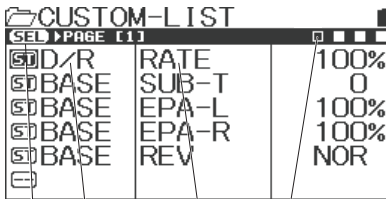
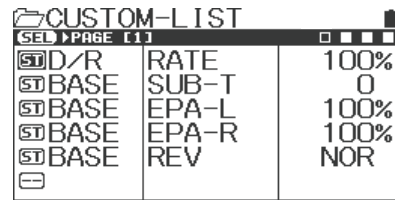

Channel Selection

Item Selection

Page Selection
(Select Button)

Function Selection

*Custom List is previously set for the type.
Customize the Custom List as you wish.

*Depending on the feature/item, there are things you cannot set.

CUSTOM-LIST SETTING

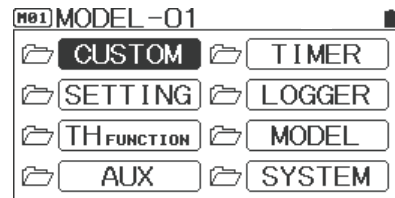
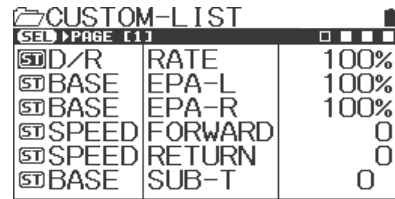

ENTER ↓ ↑ BACK

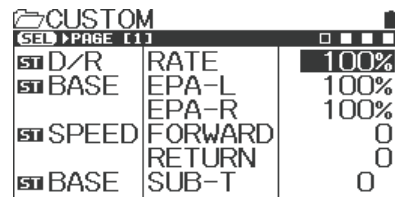

AUX TYPE

- A feature to set the performance of AUX1 and AUX2 (3ch and 4ch).

1)Select [SYSTEM] with the multi-selector and determine with the Enter operation.

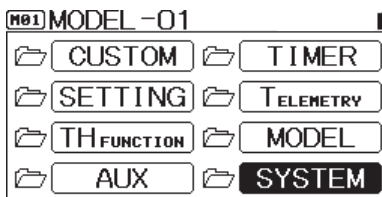

2)Select [AUX TYPE] with the multi-selector and determine with the Enter operation.

ENTER ↓ ↑ BACK

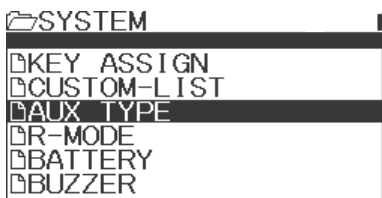

ENTER ↓ ↑ BACK

3)Set AUX TYPE with the multi-selector.

- Setting Items:

TYPE	MODE
STEP	1/2/5/10/20/25/50/100
POINT	2/3/4/5/6
4WS	2mode/3mode/4mode
MOA	1/2/5/10/20/25/50/100
AUX MIX	ST-mix/TH-mix
CODE5	USER/SVZ/SVD
CODE10	USER/SV-STK

- Default : AUX1: STEP MODE: 5
AUX2: STEP MODE: 5

*Action image of 4WS Mode setting

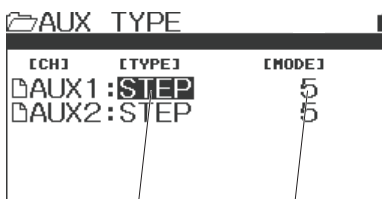

Switching Type MODE Setting

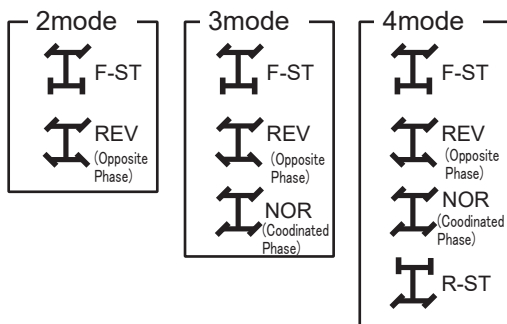

*For ST-mix, mixing is in effect from Steering onto AUX; for TH-mix, from Throttle onto AUX.

*When setting AUX TYPE to CODE, change of setting of the compatible equipment can be done from the transmitter.

Compatible equipment includes speed controllers like SUPER VORTEX ZERO and SV PLUS ZERO, and SGS-01C/ SGS-01D.

*When AUX TYPE is set to CODE, do not connect any equipment that are not compatible to AUX1 and AUX2 (3ch and 4ch) of the receiver. If you connect equipment that is not compatible, the connected equipment will be failed.

*For POINT AUX, see P. 33, for CODE AUX, see P.36.

*CODE10 is a compatible feature to SUPER VORTEX Gen2/STOCK.

*When setting MODE to USER with CODE5/CODE10, you can freely register names of each item.

Usage of each feature

System Menu

SYSTEM

RACING MODE [R-MODE]

- A feature to adjust the running characteristics of your RC car by switching the Racing Mode so that the features compatible to the Racing Mode can respond to your RC car and road conditions.
- It allows you to set two setting values of R1 and R2 individually for features that are compatible to the Racing Mode for each Model Memory, and to change by the switches that are assigned during operation.
- As a default, ON/OFF of R-MODE is not assigned to the switch.

- 1) Select [SYSTEM] with the multi-selector and determine with the Enter operation.
- 2) Select [R-MODE] with the multi-selector and determine with the Enter operation.
- 3) Set the features that corresponds to the action of the Racing Mode with the multi-selector.
Channel selection is done by the Select button.

- Setting range:
R-MODE: OFF/2
Compatible equipment: Each Feature ON/OFF

- Default :
R-MODE: INH
Compatible equipment: Each Feature OFF

- Compatible Equipment
 - ST/TH: D/R, SPEED, CURVE, TRIM
 - AUX: D/R, SPEED, CURVE, TRIM, AUX

- 4) By setting the feature of R-MODE onto the switch and operating during running, you can switch to the Racing Mode.
The Assignments feature allows you to add changes to the Trim lever and the switch (P. 51, 52).

*Set according to a setting change of SUPER VORTEX, tire wear, change of the road condition.

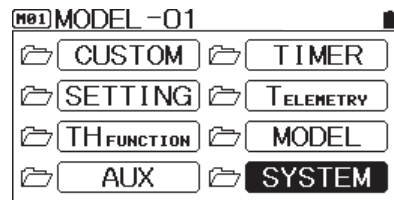

ENTER ↓ ↑ BACK

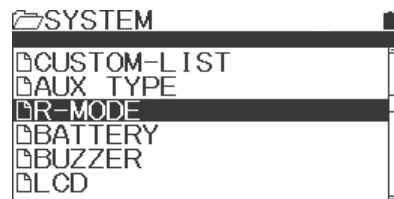

ENTER ↓ ↑ BACK



CHANNEL SELECTION

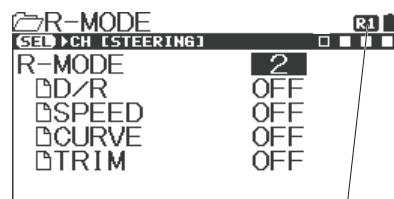

RACING MODE DISPLAY

BATTERY

- You can change the voltage setting of the battery alarm of the transmitter.
- By selecting Type [DRYx3 (Batteries)/Ni-MHx3 (Nickel Hydride)/Li-Pox1 (Lithium Polymer), CUSTOM], you can set the alarm easily.

*When selecting CUSTOM with the Type, you can set ALERT VOLT that sets voltage to make Alarm go off and LIMIT VOLT of the lower voltage.

- TH SLOW (Throttle Slow) is a feature to limit (50%) the operating quantity of the throttle's high side when the battery voltage of the transmitter becomes LIMIT VOLT (Fail-Safe feature).

- 1) Select [SYSTEM] with the multi-selector and determine with the Enter operation.
- 2) Select [BATTERY] with the multi-selector and determine with the Enter operation.
- 3) Setting TYPE

Set TYPE for the battery to be used with the multi-selector.

- Setting range: DRYx3 (Batteries)
Ni-MHx3 (Nickel Hydride)
Li-Pox1 (Lithium Polymer)
CUSTOM: ALERT VOLT 3.0 ~ 5.0v
LIMIT VOLT: 2.7 ~ 5.0v
- Default: DRYx3 (Batteries)

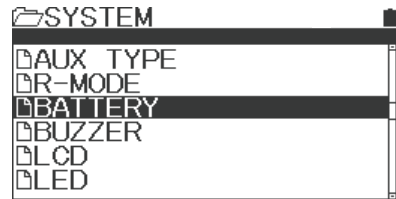

ENTER ↓ ↑ BACK

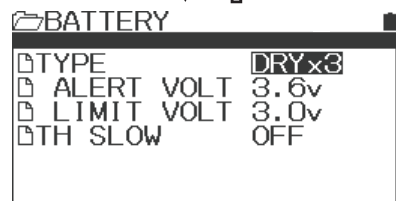

BUZZER

- You can set operating sounds of key operation, Trim and Switch and the buzzer scales.
- For key operation only, you can set the first and last half of the operation sound.
- You can set 5 steps of the volume and 7 types of scales.

- 1) Select [SYSTEM] with the multi-selector and determine with the Enter operation.
- 2) Select [BUZZER] with the multi-selector and determine with the Enter operation.
- 3) Setting Tone and Volume

You can switch between Tone (scales) and Volume (Sound Volume) with Select button operation. Select an item to change setting to adjust.

- Setting Items: KEY-CLICK
TLM1-ALERT
TLM2-ALERT
VOLT-ALERT
TIMER
INTERVAL
LAP-NAVI

*You can set the first and last half of the operation sound for KEY CLICK tone (scales).

- Setting range: TONE 1~7
VOLUME OFF ~ 5

- Default : VOLUME 4
TONE 1 (KEY CLICK 1 ->1)

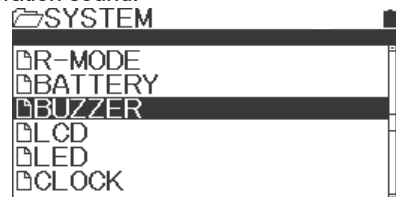

ENTER ↓ ↑ BACK

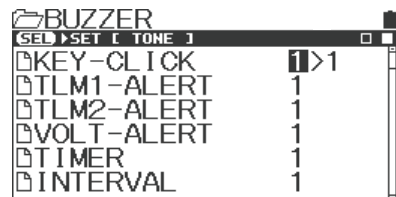

ENTER ↓ ↑ BACK

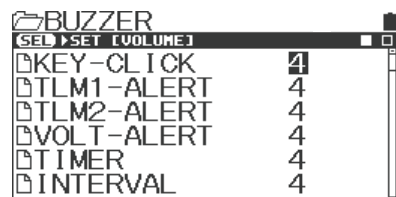

Usage of each feature

SYSTEM MENU

SYSTEM

LCD

● You can set LCD (Liquid Crystal) contrast (intensity), brightness and lighting mode (lighting time) of Back Light.

- 1) Select [SYSTEM] with the multi-selector and determine with the Enter operation.
- 2) Select [LCD] with the multi-selector and determine with the Enter operation.
- 3) Set LCD (Liquid Crystal) contrast (intensity), brightness and lighting mode (lighting time) of Back Light.

*In some contrast, you may not see screen display.

- Setting Items: CONTRAST (Intensity of Liquid Crystal)
BRIGHT (Brightness of Liquid Crystal)
LIGHTS-MODE (Backlight Lighting Mode)
LIGHT-TIME (Backlight Lighting Time)

- Setting range: CONTRAST : 0~30
BRIGHT : 0~10
LIGHT-MODE : OFF/KEY-ON/ALWAYS
LIGHT-TIME : 1~30sec

- Default : CONTRAST : 10
BRIGHT : 5
LIGHT-MODE : KEY-ON
LIGHT-TIME : 10sec

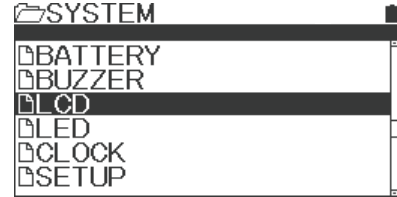

ENTER ↓ ↑ BACK

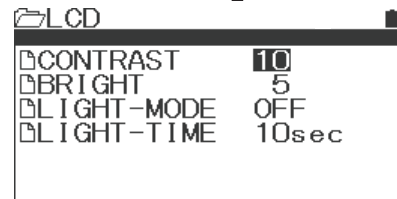

LED

● A feature to adjust the operating mode and brightness of the function LED installed on the transmitter body.

- 1) Select [SYSTEM] with the multi-selector and determine with the Enter operation.
- 2) Select [LED] with the multi-selector and determine with the Enter operation.
- 3) Set the operating mode and brightness of the Function LED.

- Setting Items: MODE (Operating Mode)
BRIGHT (Brightness of LED)
- Setting Range: MODE : ALWAYS/WAVE/OFF
BRIGHT : 0~5
*BRIGHT is only for setting ALWAYS
- Default: MODE : WAVE
BRIGHT : 5

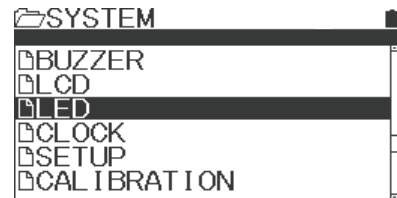

ENTER ↓ ↑ BACK

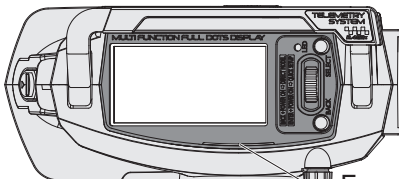
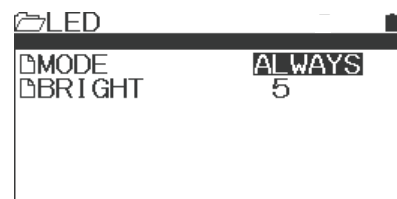

Function LED

Function LED

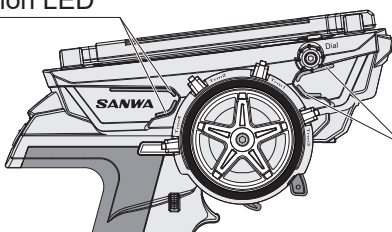

Function LED

CLOCK

- A menu to control the calendar and the clock display on the top screen and the time used.
- There are resettable [ON TIME1] that is a guideline for replacing and recharging the batteries and [ON TIME2] that is a guideline for overhaul of the main body unit.

- 1) Select [SYSTEM] with the multi-selector and determine with the Enter operation.
- 2) Select [CLOCK] with the multi-selector and determine with the Enter operation.
- 3) Set the CLOCK feature with the multi-selector.
Because setting the clock is necessary for managing log data, make sure to set the calendar and the clock.

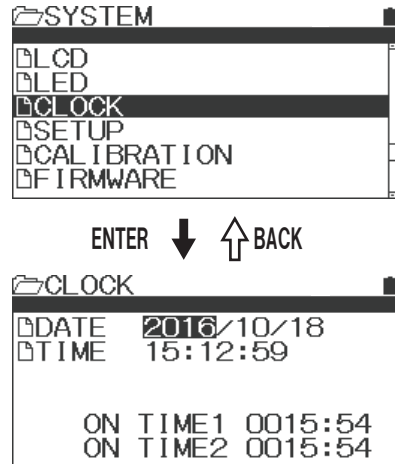

SETUP

- Select a language for the screen display during setting up and set up the unit of the temperature display for Telemetry data and the opening logo display when the power switch is turned on.

- 1) Select [SYSTEM] with the multi-selector and determine with the Enter operation.
- 2) Select [SETUP] with the multi-selector and determine with the Enter operation.
- 3) Select items to set with the multi-selector and adjust.

o Setting Items

LANGUAGE (Display Language) : ENG/JPN ° °
 UNIT (Unit of the temperature for Telemetry) : C/ F
 BOOT (Opening logo when the power switch is turned on)
 : DEMO/NONE
 RESUME (Resume) : OFF/ON

o Default

LANGUAGE : ENG
 UNIT : C°
 BOOT : DEMO
 RESUME : OFF

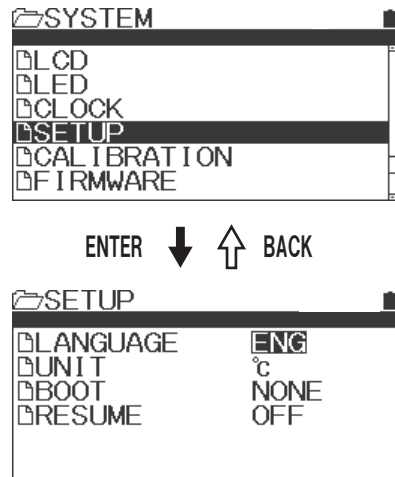

*When Resume is set to ON, it memorizes the menu at the time when power is turned off.

Usage of each feature

SYSTEM MENU

SYSTEM

CALIBRATION

- Due to wearing and tearing of the internal mechanical elements over the usage time, the neutral position and the operation angle might become off.
In such case, you can correct the neutral positions of the steering and the throttle and the operation angle.

- 1) Select [SYSTEM] with the multi-selector and determine with the Enter operation.
- 2) Select [CALIBRATION] with the multi-selector and determine with the Enter operation.
- 3) Select a channel to calibrate with the multi-selector and determine with the Enter operation.
- 4) When selecting [STEERING], operate the Enter with the steering wheel in neutral, then operate the steering wheel fully to left and right.
- 5) When entering the range, [OK] is displayed. Operate following the display.
- 6) When calibration is done, [Executed] is displayed.
- 7) If the throttle side also needs calibration, refer to the steering to set.

*Unless necessary, do not set up calibration. If the setting is not done properly, it may not operate normally.

Supplement

- If the operation does not return to normal after calibration, contact Sanwa Service.

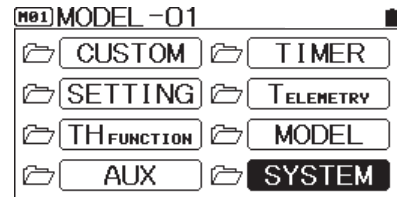

ENTER ↓ ↑ BACK

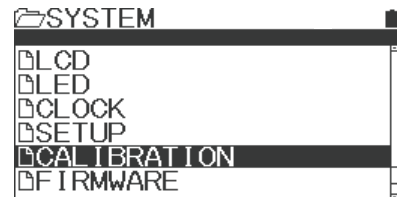

ENTER ↓ ↑ BACK

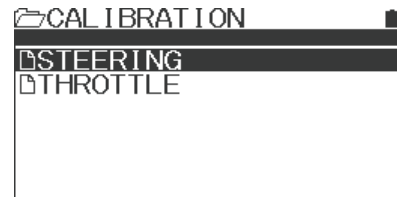

ENTER ↓

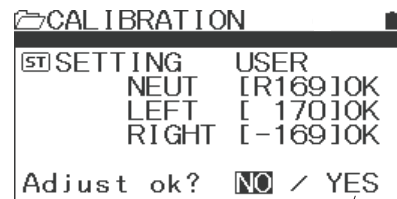
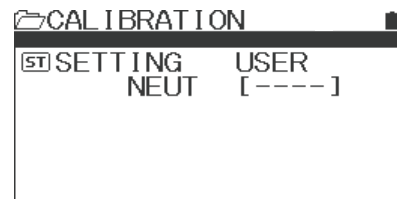

YES Selected. ↵

Select Yes, if it is OK.

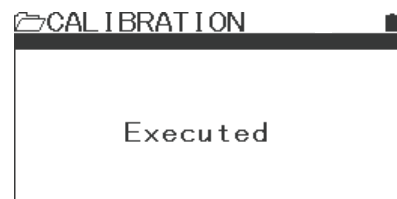

Calibration complete

FIRMWARE

● You can check the firmware version installed on the main body unit and the language file, and run updating.

- 1) Select [SYSTEM] with the multi-selector and determine with the Enter operation.
- 2) Select [FIRMWARE] with the multi-selector and determine with the Enter operation.
- 3) When updating the firmware and the language file, download the data file onto the micro SD card to proceed.

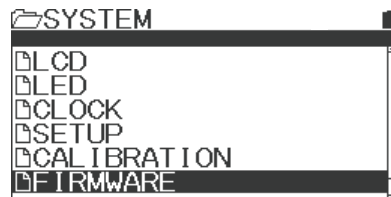

ENTER ↓ ↑ BACK

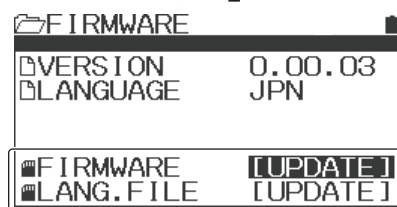

Unless you insert a micro SD card, it will not be displayed.

Key Assignments Feature List

Screen Display	Names of the Features	Trim	SW1	SW2
OFF	—— (no assigned feature)	○	○	○
ASIST-ST	Steering Drive Assistance	—	○	○
TRIM-ST	Steering Trim	○	—	—
TRIM-TH	Throttle Trim	○	—	—
TRIM-A1	AUX1 Trim	○	—	—
TRIM-A2	AUX2 Trim	○	—	—
D/R-ST	Steering Dual Rates	○	○	○
D/R-TH	Throttle Dual Rates	○	○	○
D/R-BR	Brake Dual Rates	○	○	○
CUR-ST	Steering Curve	—	○	○
CUR-TH	Throttle Curve	—	○	○
CU-R-ST	Steering Curve Rate	○	—	—
CU-R-TH	Throttle Curve Rate	○	—	—
CU-R-BR	Brake Curve Rate	○	—	—
SPD-ST	Steering Speed	—	○	○
SPD-TH	Throttle Speed	—	○	○
SP-ST-F	Steering Speed Forward	○	—	—
SP-ST-R	Steering Speed Return	○	—	—
SP-TH-F	Throttle Speed Forward	○	—	—
SP-TH-R	Throttle Speed Return	○	—	—
ALB	Anti-Lock Brake	—	○	○
ALB-PO	Anti-Lock Brake Point	○	—	—
ALB-ST	Anti-Lock Brake Stroke	○	—	—
ALB-LG	Anti-Lock Brake Lag	○	—	—
ALB-CY	Anti-Lock Brake Cycle	○	—	—
OFFSET	Offset	○	○	○
AUX1	AUX1	○	○	○
AUX1[CD1]	AUX1 [Cord 1]	○	○	○
AUX1[CD2]	AUX1 [Cord 2]	○	○	○
AUX1[CD3]	AUX1 [Cord 3]	○	○	○
AUX1[CD4]	AUX1 [Cord 4]	○	○	○
AUX1[CD5]	AUX1 [Cord 5]	○	○	○
AUX1[CD6]	AUX1 [Cord 6]	○	○	○
AUX1[CD7]	AUX1 [Cord 7]	○	○	○
AUX1[CD8]	AUX1 [Cord 8]	○	○	○
AUX1[CD9]	AUX1 [Cord 9]	○	○	○
AUX1[CD10]	AUX1 [Cord 10]	○	○	○
AUX2	AUX2	○	○	○
AUX2[CD1]	AUX2 [Cord 1]	○	○	○
AUX2[CD2]	AUX2 [Cord 2]	○	○	○
AUX2[CD3]	AUX2 [Cord 3]	○	○	○
AUX2[CD4]	AUX2 [Cord 4]	○	○	○
AUX2[CD5]	AUX2 [Cord 5]	○	○	○
AUX2[CD6]	AUX2 [Cord 6]	○	○	○
AUX2[CD7]	AUX2 [Cord 7]	○	○	○
AUX2[CD8]	AUX2 [Cord 8]	○	○	○
AUX2[CD9]	AUX2 [Cord 9]	○	○	○
AUX2[CD10]	AUX2 [Cord 10]	○	○	○
TIMER	Timer	—	○	—
TE-CLR	Telemetry MAX Clear	—	○	○

Settable...「○」 Not Settable...「—」

About installing the sensor

About installing the sensor and a compatible receiver (RX-461/RX-462)

- When installing the RPM sensor, attach the enclosed reflective decals to the point to measure number of rotations (e.g.: a pinion gear or spur gear), cut out the sensor attachment stay from a polycarbonate board or aluminum angles and fix the RPM sensor so that the infrared sensor of the RPM sensor is able to detect. When the RPM sensor is detecting properly, the LED of the receiver lights in green (or goes off).
*The recommended distance between the infrared sensor and the reflective decals (detecting part) is 1mm.
- Regarding how to use the enclosed reflective decals for the RPM sensor, cut out white or black reflective decals (about 2mm diameter) and attach them onto the point to measure the number of rotations so that RPM sensor is able to detect. Depending the color of the reflective decals, the receiver LED responds differently when the sensor detects. When the reflective decals pass in front of the infrared sensor, a green LED light is on for white decals and a green LED light goes off for black decals.
*When checking the performance of the RPM sensor, turn on only the power. Switch off the receiver side. If the power switch of the transmitter side is on at the same time, the blue LED will be on when indicating signal is being received. You cannot check the green light is on/off when the sensor is detecting.
- The enclosed RPM sensor uses an infrared system, thus it is affected by the sunlight. When the sensor cannot detect properly, try to protect the infrared sensor from the sunlight.
- When installing the RPM sensor to a car with a different driving system layout, refer to the following.

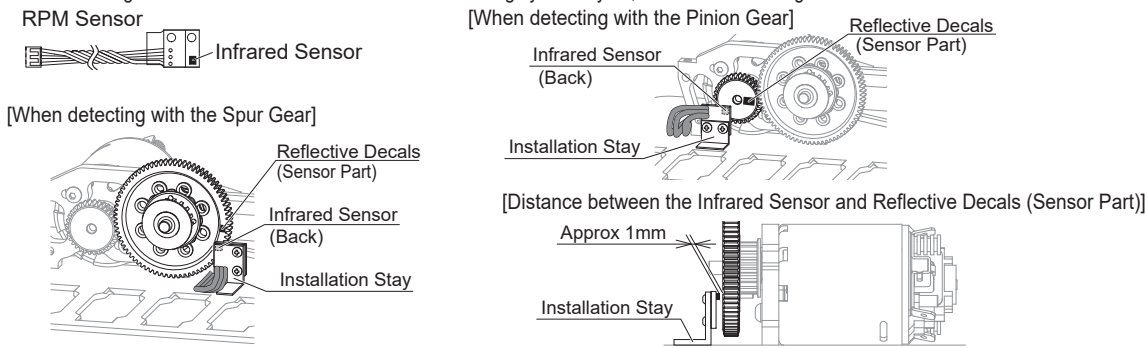

- Attach the sensor part of the temperature sensor tightly onto the subjected item to measure. Since the sensor part is extremely sensitive to temperature, secure the sensor part with a double adhesive tape so that it will not be affected by the ambient air.

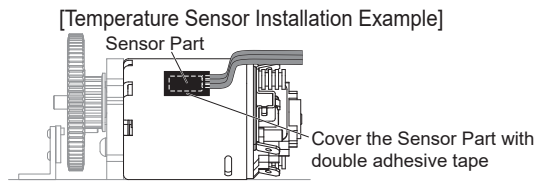
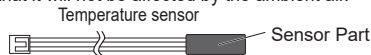

- Make sure the cords of the RPM sensor, the temperature sensor and the sensor part are secured so that they will not touch or will not be pulled into the rotating parts or moving parts of the car.
- Make sure not to hurt yourself when mounting the RPM sensor and the temperature sensor.

LED

temp.1 : Temp. sensor1

temp.2 : Temp. sensor2

r.p.m. : RPM sensor

Temperature sensor

Sensor Part

RPM sensor

Sensor Part

Dust Cover for the Receiver

- When connecting a sensor to the receiver, replace the connector cover of the receiver top and connect the temperature sensor and RPM sensor.
- For a connector that does not connect a sensor, cut the dust cover for the receiver to use.
- Attach the sensor part of the temperature sensor tightly to a subject to measure the temperature. Since the sensor part is extremely sensitive to temperature, secure the sensor part so that it will not be affected by the ambient air.
- When installing the RPM sensor, attach the reflective decals onto the point to measure the number of rotations and fix the RPM sensor so that the sensor part of the RPM sensor is able to detect. When the RPM sensor is detecting properly, the LED of the receiver lights in green (or goes off).
*The recommended distance between the RPM sensor and the detecting part is 1mm.
- When the point to measure the number of rotations is black, cut the white reflective decals; when the point to measure is white, cut the black reflective decals to attach so that the RPM sensor is able to detect them. Depending on the reflective decals used, the receiver LED lights in green or it goes off when the sensor detects.
- The RPM sensor uses an infrared system, thus it is sensitive to the sunlight. When the sensor cannot detect properly, try to protect the infrared sensor from the sunlight.
- Make sure the cords of the temperature sensor, the RPM sensor and the sensor part are secured so that they will not touch or will not be pulled into the rotating parts or moving parts of the car.
- Make sure not to hurt yourself when mounting the RPM sensor and the temperature sensor.



- If the connector is disconnected due to a vibration during operation, it can cause runaway. Connect the connector of the receiver, servos and switches securely.
- Because the receiver is susceptible to vibration, impact and water, make sure to take measures for vibration-proof and waterproof. Negligence of taking these measures can cause runaway.
- When installing the receiver, keep the receiver away from a carbon chassis and metallic chassis.
- If metal parts installed on an RC car touch each other, it can cause noise that affects reception performance and it can cause runaway.
- Make sure to install a noise killer condenser on the brush motor for electric RC cars. Without a noise killer condenser, it can cause noise and runaway.
- For R/C System parts such as the transmitter, receiver, servos, FET Speed Controller and transmitter battery, use genuine SANWA products.
- *When combining products other than genuine SANWA products, modifying, adjusting or exchanging parts is done at a place other than SANWA, we do not take responsibility.

About installing the sensor

Index

A	
Anti-Lock Brake [ALB]	P.31
AUX	P.33-36
AUX Mixing [AUX-MIX]	P.35
B	
BASE	P.25-28
BATTERY	P.56
BIND	P.49, P.50
BUZZER	P.56
C	
CALIBRATION	P.59
CODE AUX	P.36
Curve [CURVE]	P.21-24
D	
DOWN TIMER	P.39
Dual Rates [D/R]	P.19
E	
End Point Adjustment [EPA]	P.27, P.28
F	
Fail Safe [F/S]	P.25
4-Wheel Steering [4WS]	P.34
G	
GRAPH SETTING	P.44
I	
Interval Timer [INT TIMER]	P.39
K	
Key Assignments Switch [KEY ASSIGN SW]	P.51
Key Assignments Trim [KEY ASSIGN TRIM]	P.52
L	
LAP TIMER	P.38
LCD	P.57
LED	P.57
M	
MODEL	P.45-48
MODEL CLEAR	P.48
MODEL COPY	P.47
MODEL NAME	P.46
MODEL SELECT	P.45
Motor On Axel [MOA]	P.34
O	
Offset	P.32
P	
POINT AUX	P.33
Q	
QUICK SETUP	P.17, P.18
R	
Reverse [REV]	P.26
S	
SETTING	P.19-32
SPEED	P.20
STEP AUX	P.33
SUB TRIM	P.26
SYSTEM	P.49-60
T	
TELEMETRY SETTING	P.43
TELEMETRY SWITCH	P.44
Throttle Type [TH TYPE]	P.32
TIMER	P.37-39
TRIM	P.29, P.30

When this happens•••

Symptom	Cause	Measure
There is no power.	Batteries are consumed. Batteries are placed improperly.	Replace with new batteries or recharged batteries. Reinstall the batteries as the polarity is indicated.
Power is cut off occasionally.	Bad connection of connectors.	Bring to Sanwa Service
Insufficient length	Batteries are consumed.	Replace with new batteries or recharged batteries. If the problem cannot be solved, please contact Sanwa Service
Alarm will not stop.	Battery voltage of the transmitter is decreasing.	Replace with new batteries or recharged batteries.
There is no click sound when pressing the key.	Volume of the BUZZER feature is OFF (0).	Check BUZZER feature (P.56).
The servo speed is slow.	SPEED feature is set to minus.	Check SPEED feature (P.20).
	Battery voltage of the receiver is decreasing.	Replace with new batteries or recharged batteries.
	Linkage of the car body side is heavy.	Check if the Linkage of the car body side moves lightly.
Rudder angles of left and right are different even when they are aligned.	Trim neutral is not aligned.	Align Trim and reset EPA. (P.29, 30)
When operating, the servos will not work on both ends.	Rudder angle settings of D/R and EPA are too large.	Set either value to below 100%. (P. 19, 27, 28)
The servo will not move when operating Trim.	One side of the Trim movement range is full.	Reset the servo horn and the Trim center. (P. 29, 30)

SERVICE AND SUPPORT

This is warranted against manufacturer defects in materials and workmanship, at the original date of purchase. This warranty does not cover components worn by use or damage caused by improper voltage, tempering, modification, misuse, abuse, improper wiring, reverse polarity, moisture or using outside its intended scope of use.

Terms of this warranty can vary by region. Please read the warranty card included with your radio control system for specific warranty information.

If you have any questions or concerns, we're here to help. If you encounter a problem with your radio control system, first check the Troubleshooting Guide on Page 64.

If you require further help that cannot be solved using The Troubleshooting Guide, or if you have technical questions, please contact SANWA service center in your region.

For a complete list of distributors in your region, please visit www.sanwa-denshi.com/rc/distributors.html.

For Service In North America:

Serpent America
5121 NW 79 Ave. Unit 03,
Doral, Florida 33166 USA

Telephone: (305)-677-3253

Fax: (305)-675-0415

Email: info@serpentamerica.com

Factory Service:

Sanwa Electronic Instrument CO., LTD.
1-2-50 Yoshida-Honmachi
Higashiosaka, Osaka, 578-0982 Japan

Telephone: 81-729-62-1277

Fax: 81-729-64-2831

Email: rcintl@sanwa-denshi.co.jp

Product features and specifications can vary by region. Not all products are legal for use in all regions.

 Please note that products purchased outside of North America cannot be serviced under warranty by Serpent America. In some cases, we can make repairs for products purchased outside of North America, however, applicable repair costs and shipping charges will be applicable. For warranty claims outside North America, please contact the service center in your region.

FCC COMPLIANCE STATEMENT

This equipment has been tested and found to comply with the limits for a Class B digital device, pursuant to Part 15 of the FCC Rules. These limits are designed to provide reasonable protection against harmful interference in a residential installation. This equipment generates, uses, and can radiate radio frequency energy and, if not installed and used in accordance with the operating instructions, may cause harmful interference to radio communications. However, there is no guarantee that interference will not occur in a particular installation. If this equipment does cause harmful interference to radio or television reception, which can be determined by turning the equipment OFF and ON, the user is encouraged to try to correct the interference by one or more of the following measures:

- Reorient or relocate the receiving antenna.
- Increase the separation between the equipment and the receiver.
- Connect the equipment into an outlet on a circuit different from that to which the receiver is connected.
- Consult the dealer or an experienced technician for help.

This device complies with Part 15 of the FCC Rules and with RSS-210 of Industry Canada. Operation is subject to the following two conditions:

- 1) This device may not cause harmful interference, and....
- 2) This device must accept any interference received, including interference that may cause undesired operation.



Changes or modifications made to this equipment not expressly approved by SANWA may void the FCC authorization to operate this equipment.

RF Exposure Statement:

This transmitter has been tested and meets the FCC RF exposure guidelines when used with the SANWA accessories supplied or designated for this product, and provided at least 20cm separation between the antenna the user's body is maintained. Use of other accessories may not ensure compliance with FCC RF exposure guidelines.

Le present appareil est conforme aux CNR d'Industrie Canada applicables aux appareils radio exempts de licence. L'exploitation est autorisee aux deux conditions suivantes :

- (1) l'appareil ne doit pas produire de brouillage, et*
- (2) l'utilisateur de l'appareil doit accepter tout brouillage radioelectrique subi, meme si le brouillage est susceptible d'en compromettre le fonctionnement.*



SANWA ELECTRONIC INSTRUMENT CO., LTD.

**1-2-50 Yoshida-Honmachi
Higashiosaka, Osaka, 578-0982 Japan**

Telephone: 81-729-62-1277

Facsimile: 81-729-64-2831

Email: general@sanwa-denshi.co.jp

Features and Specifications are Subject to Change Without Notice.

All contents © 2016 Sanwa Electronic Instrument Co., LTD.

All Rights Reserved. Revision 1 11.25.2016